



저작자표시-비영리-변경금지 2.0 대한민국

이용자는 아래의 조건을 따르는 경우에 한하여 자유롭게

- 이 저작물을 복제, 배포, 전송, 전시, 공연 및 방송할 수 있습니다.

다음과 같은 조건을 따라야 합니다:



저작자표시. 귀하는 원저작자를 표시하여야 합니다.



비영리. 귀하는 이 저작물을 영리 목적으로 이용할 수 없습니다.



변경금지. 귀하는 이 저작물을 개작, 변형 또는 가공할 수 없습니다.

- 귀하는, 이 저작물의 재이용이나 배포의 경우, 이 저작물에 적용된 이용허락조건을 명확하게 나타내어야 합니다.
- 저작권자로부터 별도의 허가를 받으면 이러한 조건들은 적용되지 않습니다.

저작권법에 따른 이용자의 권리는 위의 내용에 의하여 영향을 받지 않습니다.

이것은 [이용허락규약\(Legal Code\)](#)을 이해하기 쉽게 요약한 것입니다.

[Disclaimer](#)

碩士學位論文

**Development of Electrohydrodynamic Inkjet Printing
for Thin Film Transistor**



濟州大學校 大學院

에너지응용시스템學部 電子工學專攻

薩利姆汗

2011 年 2 月

Development of Electrohydrodynamic Inkjet Printing for Thin Film Transistor

共同指導教授 都良會, 崔勁賢

薩利姆汗

이 論文을 工學 碩士學位 論文으로 提出함

2011 年 2 月

薩利姆汗의 工學 碩士學位 論文을 認准함

審査委員長

이 광만



委員

고성택



委員

도양희



濟州大學校 大學院

2011 年 2 月

Development of Electrohydrodynamic Inkjet Printing for Thin Film Transistor

Saleem Khan

(Supervised by Professor Dr. Yang Hoi Doh)

(Co-Supervised by Professor Dr. Kyung Hyun Choi)

A thesis submitted in partial fulfillment of the requirement for the degree of
Master of Engineering.

2010. 11.

This thesis has been examined and approved by



Thesis Committee chair, Kwang-Man Lee, Prof. of Electronic Eng.



Thesis Supervisor, Yang-Hoi Doh, Prof. of Electronic Eng.

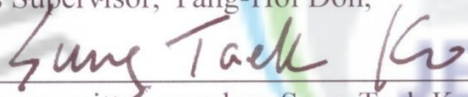

Thesis committee member, Sung-Taek Ko, Prof. of Electronic Eng

November 2010

Date

Major of Electronic Engineering

GRADUATE SCHOOL

JEJU NATIONAL UNIVERSITY



Dedicated to
My Parents, Family and Teachers

Acknowledgments

Starting with the name of Almighty Allah, the most merciful, the most beneficent. I would like to present my humble gratitude in front of Allah Almighty, Who enabled me to accomplish the dignified cause of education and learning, and I would pray Him that He makes me able to utilize my knowledge and edification for the betterment of humanity and its development.

I am heartily thankful to my supervisors, Prof. Yang Hoi Doh and Prof. Kyung Hyun Choi, whom encouragement, guidance and support from the initial to the final level enabled me to develop an understanding of the subject. This thesis would not have been possible without their keen interest and valuable support. Their positive attitude made this work very enjoyable and interesting. I greatly appreciate the fruitful discussions and favoring research environment provided by Prof. Choi, which gave me a broad vision to carry out my research in the right and correct direction. Also I would like to pay my thanks to Dr. Dong Soo Kim for his full support to access KIMM (Korean Institute of Machinery and Materials) facilities for results analysis.

I extend my thanks to all my lab colleagues and co-workers for the fruitful discussions and helping me out through all the ups and downs of my stay here in Korea. They have been great resources of encouragement and insight into many topics as well as great sounding board for my bizarre ideas. I greatly appreciate the facilitating efforts by my senior Pakistani fellows and their families.

My deepest gratitude goes to my parents for always supporting and encouraging me. None of my endeavors would be possible without them.

Lastly, I offer my regards and blessings to all of those who supported me in any respect during the completion of the project.

Contents

Abstract	1
Chapter.1. Introduction	
1.1. Background	5
1.2. Motivation	7
1.3. Thesis Overview	7
Chapter. 2. Printed Electronics and printing Technologies	
2.1. Printed Electronics	10
2.2. Printing Technologies	12
2.3. Key Printing technologies	13
2.4. Contact printing technologies	14
2.5. Non-Contact or Inkjet printing technologies	15
2.5.1. Thermal Inkjet.....	17
2.5.2. Piezoelectric Inkjet System	17
2.5.3. Electrohydrodynamic Inkjet Printing	19
2.6. Applications	25
Chapter. 3. Printed Thin Film Transistors	
3.1. Introduction to thin film transistor and its basic structure	29
3.2. Basic device operation	31
3.3. Material selection	32
3.3.1. Colloidal solution used in our research	35
3.4. Substrate selection	36
Chapter. 4. Development of Electrostatic Inkjet Head by Integrating Metallic and Silica capillaries for Stable Meniscus	
4.1. Introduction and motivation for development of an Inkjet head	40
4.2. Nozzle head design	41
4.2.1. Vertically inserted electrode head design	41
4.2.2. MEG nozzle head configuration	42

4.3.	Electric field simulation	44
4.4.	Experimental analysis and comparative study	45
4.5.	Results and discussion	47
4.6.	Conclusions	49
Chapter. 5. Direct patterning and Electrospray Deposition through EHD for Fabrication of Printed Thin Film Transistor		
5.1.	Introduction	52
5.2.	Comparison of Analytical and Experimental Values of Onset Voltages for Electrohydrodynamic Phenomena	53
5.3.	Colloidal solution used	55
5.4.	Inkjet nozzle head development	56
5.5.	Experimental procedure	56
5.5.1.	Contact angle analyzer experiment	56
5.5.2.	Electrohydrodynamic patterning and spray experiments	57
5.6.1.	Contact angle analyzer results	61
5.6.2.	SEM and AFM analysis of the deposited layers	62
5.7.	TFT fabrication by integrating electrohydrodynamic printing and spray steps....	65
5.7.1.	Bottom gate structure	65
5.7.2.	Top gate structure	66
5.8.	Conclusion	68
Chapter. 6. Summary, Conclusion and future Recommendations		
6.1.	Summary	71
6.2.	Conclusion and future recommendations	72
	Publications List	74

List of Figures

Fig.2.1. Comparison of conventional lithography and inkjet printing fabrication steps for Microelectronics	11
Fig.2.2. Different Printing Techniques and approaches followed.	13
Fig.2.3. Different Non-Contact or Inkjet Technologies.	17
Fig.2.4. Electrostatic inkjet classification based on different ground configurations.....	20
Fig.2.5. (a) Pendant drop when voltage is not applied, b) Cone jet when voltage is applied.....	21
Fig.2.6. (a) Effective forces at the meniscus, (b) Emission of jets upon voltage application.....	21
Fig.2.7. Different modes of EHD	24
Fig.3.1. Basic schematic of thin film transistor	29
Fig.3.2. Four general thin film transistor configurations, including, (a) staggered bottom-gate, (b) Coplanar bottom-gate, (c) staggered top-gate, (d) coplanar top-gate.....	30
Fig.3.3. (a) Basic structure of a TFT and corresponding energy band diagrams as Viewed through the gate for several biasing conditions,(b) equilibrium, (c) $V_{GS} < 0V$, and (d) $V_{GS} > 0V$	31
Fig.3.4. Generalization of Ink selection	33
Fig.3.5. Relation of Melting point against particle size	34
Fig.3.6. Common flexible substrates and their sustainable temperatures	36
Fig.4.1. VIE nozzle made from PDMS	42
Fig.4.2. Upper part of the nozzle with holder	42
Fig.4.3. Lower part of the nozzle	43
Fig.4.4. MEG nozzle configuration	43
Fig.4.5. Dimensions of the upper and lower parts of the nozzle	43
Fig.4.6. Electric field lines simulation of VIE	44
Fig.4.7. Electric field lines simulation of MEG	44

Fig.4.8. Simulation of the field strength at three points using VIE	45
Fig.4.9. Simulation of field strength at three points using MEG	45
Fig.4.10. Schematic diagram of electrohydrodynamic inkjet system.....	46
Fig.4.11. Lab developed system	47
Fig.4.12. (a) Unstable meniscus and jetting by using VIE with polyimide substrate	
b) Stable meniscus and jetting by using MEG capillary with polyimide substrate.....	48
Fig.4.13. Trend of printed lines on polyimide substrate	48
Fig.4.14. (a) Patterning on polyimide substrate with vertically inserted electrode capillary	
head, b) Patterning on polyimide with metallic enclosed glass capillary head	49
Fig.5.1. (a) Schematic of meniscus and affecting forces. b) Meniscus shape after	
Application of electric potential	54
Fig.5.2. (a) Droplets on hydrophilic, (b) Hydrophobic surfaces	57
Fig.5.3. Contact angle analyzer	57
Fig.5.4. Different behavior of meniscus upon increasing the voltage for EHD patterning ..	59
Fig.5.5. Schematic of electrospray system	59
Fig.5.6. Lab developed electrospray system.....	60
Fig.5.7. Different meniscus behavior of electrospray upon increasing voltage	60
Fig.5.8. (a) Contact angle of ZnO, (b) SiO ₂ on glass substrate	62
Fig.5.9. Schematic of substrate heating affect	63
Fig.5.10. (a)SEM analysis of electrospray ZnO,(b)SEM analysis of electrosprayed SiO ₂	63
Fig.5.11. (a)Layer profile of electrosprayed ZnO,(b) Layer profile electrosprayed SiO ₂	63
Fig.5.12. AFM analysis of ZnO surface, (a) 3D view and (b) Surface roughness	64
Fig.5.13. AFM analysis of SiO ₂ surface, (a) 3D view and (b) Surface roughness	64
Fig.5.14. (a) 3D view of the printed lines, (b) Thickness graph of the printed lines.....	65
Fig.5.15. Processing steps for bottom gated TFT, (a) gate line on the glass substrate,	
(b & c) Mask for deposition of dielectric and semiconductor layers, (d, e & f) Source and	
drain deposition with stencil mask used	66
Fig.5.16. Processing steps for top gated TFT, (a) Source and drain, (b) Electro spray	
Of ZnO on source and drain contacts, (c) Electro spray of SiO ₂ on ZnO layer, (d) Parallel	
gate line with source and drain, (e) Cross gate line with source and drain.....	67

List of Tables

Table 2.1. Key contact and non-contact printing techniques.....	13
Table 2.2. Summary of advantages and disadvantages prominent inkjet systems	25
Table 4.1. Experimental parameters	47
Table 5.1. Experimental parameters for Ag patterning	58
Table 5.2. Experimental parameters for SiO ₂ and ZnO electrospray	60
Table 5.3. Contact angle analysis of ZnO on glass substrate.....	61
Table 5.4. Contact angle analysis of SiO ₂ and ZnO	61

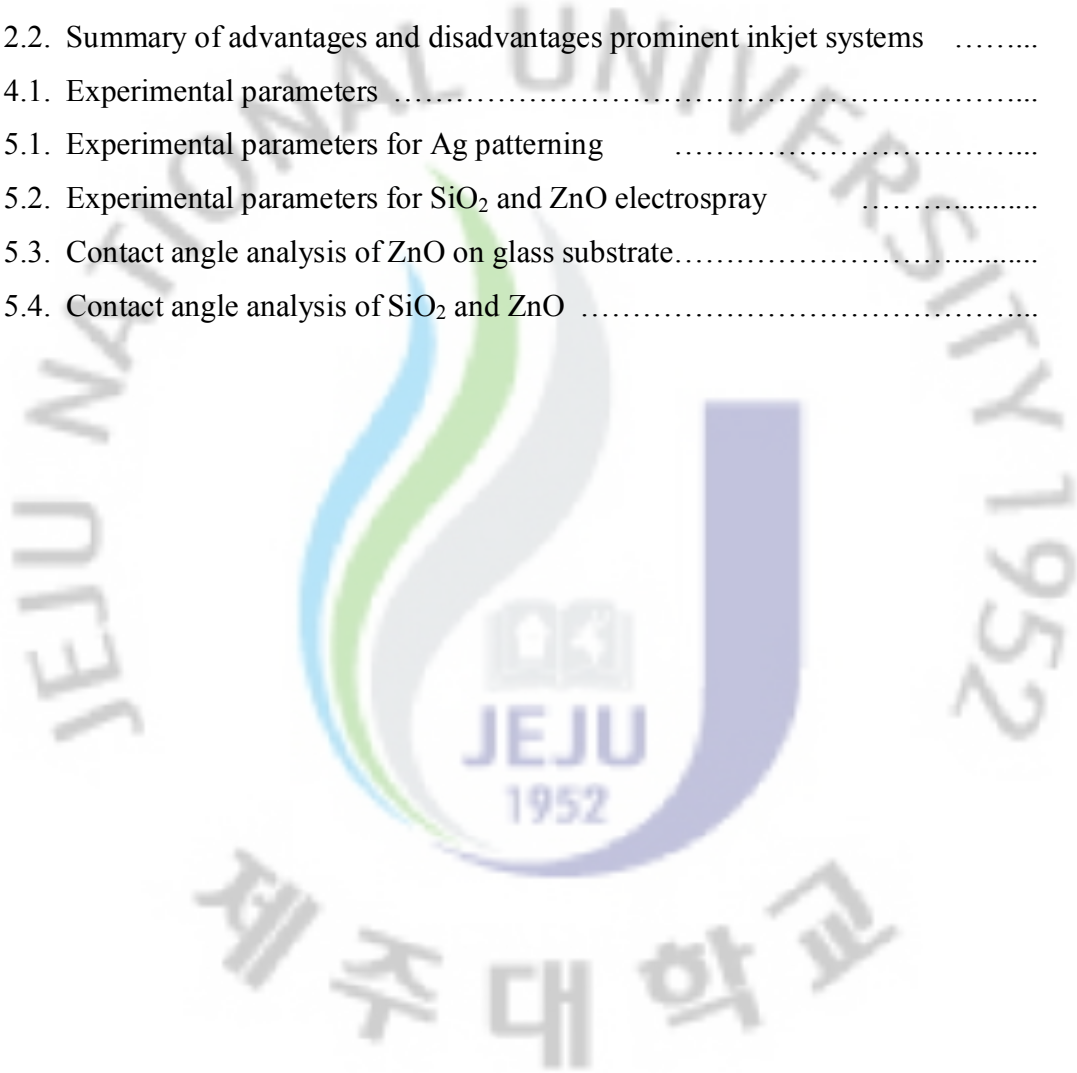



Abstract

잉크젯 기술을 사용한 마이크로 일렉트로닉스를 직접 구현하기 위한 연구 개발에 커다란 진전이 있었습니다. 열 및 압전 액추에이터를 기반으로 제팅 시스템은 상용화되고 있습니다. 하지만 제팅 시스템은 매우 작은 장치를 필요로 하는 미래 세대의 요구 사항을 충족하기 위해서는 몇 가지 근본적인 제한이 있습니다. 먼저 열 거품 액추에이터는 유기 물질과 호환되지 않습니다. 노즐의 배열에 사용되는 용제가 조기 증발하여 오리피스에서 재료의 특성과 유기 입자의 응집을 바꿔버립니다. 그리고 압전 액추에이터에서는 노즐에서 떨어지는 작은방울을 노즐 크기보다 작게 생성하기가 어렵습니다. 또한 가열 및 압전 요소로 구성된 잉크젯 헤드는 구조가 복잡하다는 단점이 있습니다. 대체 기술인 EHD 잉크젯 프린팅은 열 또는 압전식 액추레이터보다 더 미세한 물방울을 만들 수 있으며 더 간단한 구조를 갖는 장점을 가지고 있습니다.

일반적으로, (위에서부터) 수직으로 삽입된 금속전극은 잉크젯 노즐에 포함된 콜로이드 용액 및 카운터 전극이 안정적인 원뿔의 jet 와 유체의 방출을 위한 전기장을 방출하는데 사용됩니다. 수직으로 고정된 잉크젯 헤드의 전극위치가 큰 문제 중에 하나였는데 그 이유는 상수 매개 변수로써 실험의 반복에 대한 유지 관리가 매우 어렵다고 여겨졌었기 때문입니다. 또한 방해와 매우 높은 전기적인 가능성을 더 하기 위해 마이크론 크기로 제작된 팁으로 인한 진동 그리고 불안정한 메니스커스(모세관 속의 액체 표면이 만드는 곡선)는 기질에서의 규칙적이지 않고 매끈하지 못한 패턴 라인의 경계면을 야기합니다. 잉크 채널의 전극의 집중은 잉크젯 헤드 설계를 복잡하게 만듭니다. 잉크 저장 충전소에서 뒤로 흐르는 액체와 나노입자의 집합체는 VIE 의 구성요소 중 일부입니다. 유체 채널에서 전극위치를 유지한 상태로 유리로 감싸진 금속 모세관을 사용하여 반복 실험 매개 변수를 얻을 수 있는 또 다른 새로운 방법의 노즐이 개발 되었습니다. 금속 모세관은 유체 채널뿐만 아니라 전극의 역할을 잘 수행합니다. 새로운 구성으로 Jetting 을 합하기 위해서는 낮은 전압이 필요합니다. 유체 흐름에 장애물을 피할 수 있으며, 최소 너비와 패턴을 구현할 수 있습니다. 노즐이 성공적으로 설계되었으며 새로운 잉크젯 헤드로 얻어진 결과는 높은 균일성, 화면 비율, 매끈한 경계, 단순하고 쉬운 설치 절차의 가능성을 제시합니다.

이 논문에서는 새로 개발한 EHD 잉크젯 인쇄 헤드와 전기 분무 증착 시스템을

이용하여 박막 트랜지스터의 제조 단계의 완전한 집합을 개발하고 있습니다. 전기 분무를 통한 박막 트랜지스터 (TFT)의 유전체 및 반도체형 레이어의 직접 증착은 기존 증착 관행에 대한 세심한 주의를 요합니다. 다른 증착 기술에 비해, 전기 분무 증착은(ESD) 높은 증착 효율 (최대 80 %)과 전기적인 힘에 의한 방울로 공정 단계를 줄여주는 이점을 갖습니다. 증착된 필름의 품질은 필름디자인 (노즐 - 기판 거리와 노즐 직경) 및 분사 매개 변수 (액체 공급 속도, 전기 가능성)뿐만 아니라 소재 특성 (솔루션 점도, 전도성, 흡수 및 밀도) 사이의 상호 작용에 따라 필름의 품질이 결정됩니다.

박막 트랜지스터의 완전한 원형은 EHD의 patterning 및 전기 분무 기술을 사용하여 성공적으로 제조되었습니다. 은이 포함된 콜로이드 용액은 전도성 소스, 드레인 및 장치의 게이트 접촉부 인쇄에 사용됩니다. 나노입자단위의 50 μm 음로 최소의 채널 길이는 연구실에서 개발된 MEG (Metallic Enclosed Glass) 잉크젯 헤더를 사용하여 박막 트랜지스터의 하단 접촉부에서 얻을 수 있었습니다. ZnO 와 SiO₂ 의 콜로이드 용액의 레이어 증착에 의한 레이어는 각각 반도체와 유전체 층에 대한 전기 분무와 상단 게이트 접촉부에 프린팅을 사용하여 이루었습니다. 모든 실험에서 얻어지는 전도성 접촉부의 패턴폭은 70 μm 안에서 디지털 현미경으로 관찰할 수 있습니다. 스프레이 증착이 되는 표면 형태는 AFM 과 SEM 을 사용하여 표면의 거칠기와 두께를 분석할 수 있습니다. 표면장력, 접착력, 효과적인 확산, 접촉각과 같은 변수를 찾기 위해서 접촉각 분석 실험이 수행됩니다. 모든 실험들은 EHD 인쇄 시스템의 주위 환경에서 완성되었습니다. 이 연구에서의 모든 잉크젯 시스템 제조 방식에 대한 접근은 직접적인 박막 트랜지스터의 제조를 위한 것입니다.

Abstract

There has been a tremendous progress in research and development for direct fabrication of microelectronics using inkjet technology. Jetting systems based on thermal and piezoelectric actuators are commercialized; however they have some fundamental limitations to overcome in order to meet the requirements for the future generation of very small scale devices. Thermal bubble actuator has the heat problem when used in an array of nozzle which is also not compatible with organic materials, as heating alter material properties and facilitates agglomeration of the organic particles at the orifice by early evaporation of the solvents. In piezoelectric actuator it is difficult to generate droplet smaller than nozzle size. Also the inkjet head consisting of piezoelectric or a heating element has the disadvantage of complex structure. An alternate direct deposition technology, electrohydrodynamic inkjet printing has a greater advantage than the piezo and thermal inkjet in the ability to eject fine droplets and in simplicity of structure.

Conventionally a metallic electrode inserted vertically (from top) into colloidal solution contained in inkjet nozzle and a counter electrode is used to generate an electric field for development of a stable cone jet and ejection of the fluid. Electrode position at a fixed point in vertically inserted electrode (VIE) inkjet head is one of the big issues, which is very difficult to maintain for repeatability of experiments with constant parameters. Also the disturbances and vibrations caused by the micron sized tip due to the application of very high electric potential add to the unstable meniscus which results in nonuniformity and irregular boundaries of the pattern lines drawn on the substrate. Centralization of the electrode in the ink channel adds to the complexity of the inkjet head design. Ink bank charging, back flow of the fluid and agglomeration of nanoparticles are some of the issues with VIE configuration. Another novel method of maintaining the electrode position in the fluid channel for getting repeatable experimental parameters using a metallic capillary enclosed in a glass (MEG) nozzle has been developed. The metallic capillary serves as a fluid channel and electrode as well. Low voltage is required for uniform jetting in the new configuration. The obstructions to fluid flow are avoided and patterns with minimum width are able to be achieved. Nozzle has been successfully designed and results obtained with the new inkjet head are very promising in terms of uniformity, aspect ratio, regular boundaries, simplicity and easy installation procedures.

In this thesis a complete set of manufacture steps for thin film transistor are developed using newly developed electrohydrodynamic inkjet printing head and electrospray deposition systems. Direct deposition of dielectric and semiconductive layers in thin film transistors (TFT) through electrospray is of meticulous attention as a substitute for conventional deposition practices. Compared to other deposition techniques, electrospray deposition (ESD) bears the advantage of high deposition efficiency (up to 80%) and reduction of the process steps as the droplets are transported by electrical forces. Quality of deposited film depends on interaction between the design (nozzle-substrate distance and nozzle diameter) and spraying parameters (liquid feed rate, electrical potential) as well as material properties (solution viscosity, conductivity, absorption and density).

A complete prototype of thin film transistor has been successfully manufactured using EHD patterning and electrospray technology. Colloidal solution containing Ag (silver) nanoparticles is used for printing of conductive source, drain and gate contacts of the device. A channel length of minimum as 50 μm is achieved in the bottom contact structure of thin film transistor on glass substrate by using lab developed metallic enclosed glass (MEG) inkjet nozzle head. Layer by layer deposition of colloidal solution of ZnO and SiO₂ has been achieved using electrospray for the semiconductor and dielectric layers respectively and followed by printing a gate contact on the top. Widths of patterned conductive contacts achieved in all experiments are around 70 μm as observed by a digital microscope. The surface morphology of the spray deposited layers is analyzed using AFM and SEM for surface roughness and thicknesses achieved. For finding different parameters like, surface tension, work of adhesion, spreading co-efficient and contact angle of the solutions, contact angle analyzer experiments are performed. All the experiments were completed in ambient environment which is the true essence of EHD printing systems. All inkjet system manufacture approach is followed for the direct fabrication of a thin film transistor in this research.

Chapter 1 Introduction

1.1 Background:

Printing technologies have evolved as the most robust areas of research topics in the modern day micron scale and thin film electronics. Several techniques for printing the functional inks have been developed and employed industrially. Printing technologies have evolved in revolutionizing the electronics industry as a pathway for easy fabrication, low-cost and material efficient manufacturing processes [1]. Thin film transistors (TFTs) and flexible electronics through printing is the focal research topic of many research groups now-a-days. Printing is the easiest, environment friendly and cost effective technology. Conductive lines can be patterned via printing directly in one step instead of multi-steps involved in conventional photolithography technique. The high-resolution electrohydrodynamic printing (EHDP) and electrospray deposition (ESD) techniques are of particular interest as an alternative to conventional vacuum deposition and photolithographic patterning of various functional films such as gate electrodes, gate dielectrics, source and drain contacts and active semiconductor layers. High temperature processing steps involved in photolithography are the main bottlenecks for flexible electronics fabrication whereas direct printing is the most feasible technique for solution processed materials at room temperature. Different printing and deposition techniques have been developed and employed depending on the resolution of the print lines and layer thickness of the devices. Among all these techniques, Ink-jet printing is very simple, versatile and attractive for forming micro-size patterns for flat panel displays (FPDS), printing circuit board (PCB), semiconductor, biological, optical, and sensor devices due to its low temperature process, direct writing, and rapid prototyping process [2-4].

Jetting devices based on thermal and piezoelectric are commercialized and have been applied for the manufacture of electronic devices. However both piezo and thermal based systems have some fundamental limitations to overcome in order to meet the requirements for the future generation of devices. Thermal inkjet systems are based on the principle of forming small droplets by heating an element in the ink chamber which displaces enough fluid and makes way through the orifice of the nozzle. Certain limitations hinder the use of thermal inkjet systems for most of the applications. In the first place, materials which are heat sensitive especially organic materials which require low processing temperatures cannot be

processed by using thermal inkjet systems and most of the nozzles get blocked very frequently due to agglomeration at the orifice. Secondly the droplets produced are larger than the nozzle orifice size making it difficult for getting high resolution patterns. Thermal bubble actuator also has the heat problem when used in an array of nozzle. In piezoelectric inkjet system the heating problems are overcome by introducing a piezoelectric actuator in the ink chamber but the droplets produced are still of large size than the nozzle orifice. Also, the head consisting of piezoelectric or a heater element has the disadvantage of the complex structure [5].

Improvement in the produced structure quality, patterns size and uniformity, printing speeds, printing quality, resolution and accuracy are under constant demand. The electrohydrodynamic inkjet printing (EHDP) has a greater advantage than the piezo and thermal inkjets in the ability to eject fine droplets and in simplicity of structure. In addition to droplets ejection EHDP has the advantage of ejecting an intact jet with size as minimum as 70% from the nozzle orifice size, which adds to the promising features of electrostatic inkjet print head. Some of the performance parameters such as high frequency jetting, high aspect ratio, high resolution patterns, size of droplet and uniformity of droplets size are required to fulfill the requirements of various electronics and industrial applications [6].

Conventionally a metallic capillary is used as an ink channel which also serves as an electrode for production of an electric field by putting a counter electrode below in case of discrete setup or above the targeted substrate in an integrated setup. Another approach is also being followed for developing the inkjet nozzle head which is targeted for multi-nozzle head configuration; the electrode is inserted from top into the ink channel which serves for generating an electric field upon placing a counter electrode below or above the targeted substrate. In this configuration the voltage requirement is very high, position of the electrode is difficult to maintain in the ink chamber and repeatability of the process parameters is difficult [7]. To get uniform printed patterns, getting a very stable jet is important and it can only be obtained from a very stable meniscus. So the inkjet head can be manipulated in order to get a stable meniscus.

In this thesis, focus on the development of a stable inkjet head and its application to the manufacturing steps of a thin film transistor is applied. The newly developed inkjet head is applied for the direct patterning of source, drain and gate contacts of the transistor, while internal layers of dielectric and semiconductor are deposited using electrospray technique [8]. Main theme of the thesis is about the development of full manufacture steps of TFTs by

using EHD direct write technology. Very acceptable values of line widths, channel lengths, aspect ratio, surface roughness and layer thicknesses are achieved.

1.2. Motivation

Development of a stable inkjet head for getting micron-sized droplets and intact jets is the potential area of research in order to overcome the obstacles mentioned for Inkjet systems based on thermal and piezoelectric actuators. Electrostatic inkjet system itself has a lot of research challenges and obstructions which need to be addressed. Research on the integration of EHD technology with existing printing, patterning and deposition techniques for batch manufacturing of electronic devices is the main attractive field of study and gives way to a lot of opportunities to be explored. Integrating Inkjet printing with other efficient deposition techniques like E-spray deposition (ESD) in ambient environment is explored in this thesis work. The integration of such manufacturing techniques at normal temperatures can lead to batch production of flexible thin film electronics and make way possible for Roll-to-Roll production as well.

1.3. Thesis Overview

This dissertation focuses on three main issues related to printed electronics and are discussed in detail. First of all a stable inkjet head development for getting a stable meniscus to achieve uniform pattern lines with regular boundaries. For this purpose two types of inkjet head are manufactured and analyzed on the basis of their operation, results and experimental parameters. In operational analysis the main areas of focus are the inkjet head assembly, nozzle manufacturing, electrode configurations and process repeatability etc. In results the printed line widths, affect on meniscus and line width upon increasing the applied voltage, uniformity of the printed lines, regularity of the patterned lines, layer thickness and surface roughness. While analysis on the basis of experimental parameters include extraction voltage, flow rate and its affect on the pattern lines, various configurations by using different shapes of counter electrodes and its affect on the printed lines. It is observed on the basis of observed parameters that a metallic enclosed glass nozzle configuration gives the most acceptable results as compared to the vertically inserted electrodes configuration in the inkjet nozzle head. Metallic enclosed glass nozzle to be miniaturized further is the most feasible structure for multi-nozzle configuration for enhancing the speed of inkjet printing system. Uniform pattern lines with acceptable aspect ratios are printed on glass substrates for developing the source drain contacts of a thin film transistor. A minimum of 50 μm channel width was achieved with around 1.5 mm channel width. Line widths of around 60 ~ 70 μm are

successfully printed by using 80 um nozzle orifice. The same contact line was printed using the same nozzle configuration for the gate line as well.

The remaining chapters are divided in such a way that a detailed overview of the existing technologies, need of an alternative technology, application areas, achievements, scope and future of the new technology can be presented. An easy and effective approach for manufacture of an all printed thin film transistor has been developed by integrating EHD patterning and electrospray deposition.

Remaining chapters of the thesis is divided into the following sections,

Chapter 2 discusses about the printed electronics, printing technologies, current focus and conventional inkjet techniques for thin film devices manufacturing. Theory of EHD printing and electrospray deposition techniques are discussed in full detail and their application for fabrication of thin film transistors has been highlighted.

Chapter 3 is about the detailed theory of thin film transistors. Different structures and manufacturing approaches, feasible approaches by using EHD technology, materials and colloidal solutions, substrates and their limitations are discussed.

Chapter 4 is about the inkjet head fabrication. Head development steps and comparative study with conventional EHD inkjet nozzle heads have been discussed in detail. Experimental analysis accompanied by simulation results of both nozzle head designs have been discussed in full detail.

Chapter 5 presents the experimental procedures, manufacturing steps development, results and morphological analysis of the thin film transistor. Aspect ratios of the printed conductive lines, thickness and surface roughness of the electrosprayed deposited layers analyzed by SEM and AFM are discussed.

References:

- [1] Singh M, Haverinen H M, Dhagat P and Jabbour, Inkjet Printing—Process and its Applications, *Adv. Mater.* 2010, 22, 673–685, DOI: 10.1002/adma.200901141
- [2] E. Lee, *Microdrop Generation*, CRC Press, 2003
- [3] S. Lee, D. Byun, S. J. Han, S. U. Son, Y. J. Kim, H. S. Ko, “Electrostatic Droplet Formation and Ejection of Colloid,” *MHS*, July 31, 2004.
- [4] C.M. Ho, Fluidics-the link between micro and nano sciences and technologies, *Proc. IEEE Int. Conf. MEMS*, 2001, pp. 375–384.
- [5] Youngmin Kim, Sanguk Son, Jaeyong Choi, Doyoung Byun, and Sukhan Lee: *Journal of Semiconductor Technology and science*, Vol. 8, No.2, June, 2008

- [6] Sukhan Lee, Doyoung Byun, Daewon Jung, Jaeyong Choi, Yongjae Kim, Ji Hye Yang, Sang Uk Son, Si Bui Quang Tran, Han Seo Ko, Elsevier, 2008, p. 506-514
- [7] Droplet Ejection Behavior in Electrostatic Inkjet Driving Yuji Ishida, Keigo Sogabe, Shintaro Kai, and Tanemasa Asano Graduate School of Information Science and Electrical Engineering, Kyushu University, 744 Motooka, Nishi-ku, Fukuoka 819-0395, Japan
- [8] Kyung Hyun Choi, Saleem Khan, Dang Hyun Woo, Yang hoi Doh and Sung Jei Hong, Electrohydrodynamic Spray Deposition of ZnO Nanoparticles, Japanese Journal of Applied Physics 49 (2010) 05EC08, DOI: 10.1143/JJAP.49.05EC08



Chapter # 2

Printed Electronics and Printing Technologies

2.1. Printed Electronics:

Printed electronics is the term used for electronic devices or patterns fabricated using functional colloidal solutions. Printed electronics creates electrically functional devices by utilizing of traditional printing processes and broad range of substrates. So far the most common substrates are polymer films, ceramics, glass and silicon. Printing of functional devices on paper is also possible. In contrast to the terms organic electronics, printed electronics can utilize any solution-based material, including organic semiconductors, metallic conductors, nanoparticles, nanotubes etc. In other words, printed electronic devices comprise solution-processable electronic materials deposited with a printing method. Printing processes include processes well known from the graphics art industry such as screen printing, flexography, gravure, offset lithography and inkjet. With printed electronics functional electronic or optical inks are used to print active or passive devices, such as thin film transistors, light emitting diodes, RFID tags, resistors and capacitors etc. Examples of printed electronics components include e.g. electrodes comprising printed metal particle ink, carbon ink or conductive polymers or diodes and transistors comprising printed organic semiconductor and dielectric layer(s).[1, 2, 3]

There are several reasons, why printable electronics is gaining considerable attention. The first is that the printing process can be applied to many different kinds of substrates, and also three-dimensional printing is possible. This enables the changing of the whole system of producing electronic devices, including the design and manufacturing phases, material selection, and device structure and architecture. Second, printed electronics offers better economics to electronics manufacturing. Traditional electronics is cheap only on the mass production scale, in contrast to printing and especially inkjet printing, which offers flexible and cheap production for tailored small-volume products. Third, printing offers new business models. Inkjet technology enables also “desktop manufacturing”, which applies to small-scale micro factories with small fixed costs. The distinctive difference between printed electronics and traditional electronics manufacturing is that printing is additive whereas manufacturing electronic circuitry using lithography requires subtractive processes. Using printing technology, several process steps involving considerable material consumption, such as etching and cleaning, are substituted with a single process consisting of adding material to

the substrate. This is illustrated in Fig. 2.1. From the environmental perspective this obviously offers great reductions in waste since virtually all the material which is used in production ends up on the final product. Additive electronics manufacturing can be done using various methods [4,5].

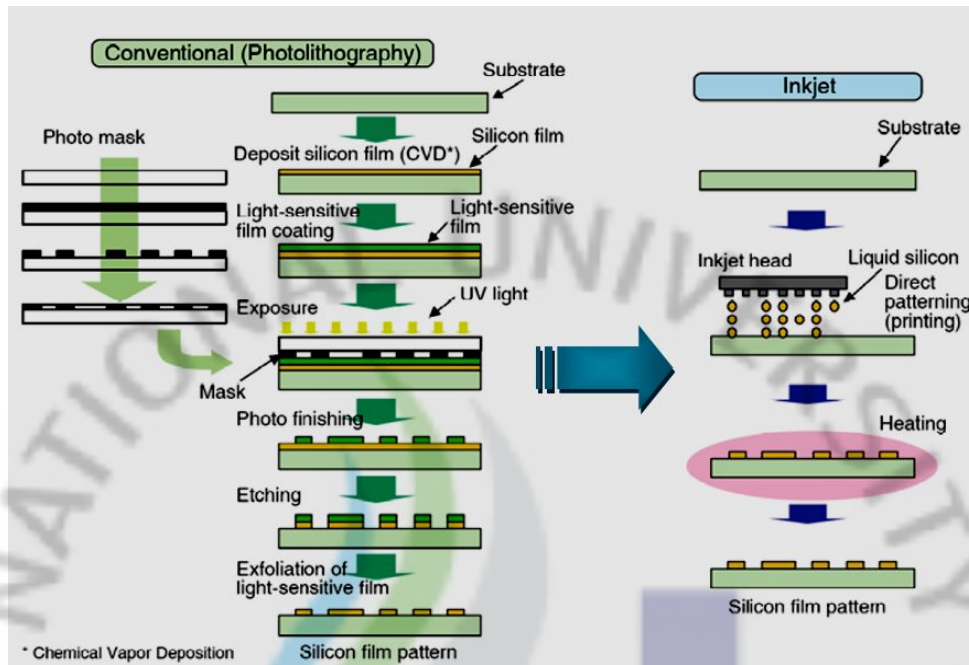

Fig.2.1. Comparison of conventional lithography and inkjet printing fabrication steps for microelectronics

Compared to conventional microelectronics, printed electronics is characterized by simpler and more cost-efficient fabrication of both high and low volume products. It enables roll-to-roll fabrication and the processes employed to manufacture printed electronics also are more flexible, enabling shorter production runs. Very small series, customized or even unique products are possible through a digital printing process. Another advantage is its processing at low-temperatures. The broad range of substrate selection is a solution, which is printable and coatable enabling also flexible products. The additive processes might prove to be more environmentally friendly. Despite its many benefits, to date the performance of printed electronics in terms of the actual function and performance is reduced compared to that of conventional electronics. It is therefore believed that printed electronics will complement, rather than compete with silicon based electronics. Printed electronics is expected to be useful for applications for low-performance but also low-cost electronics. The applications will be also new electronics products for traditionally non-electronic applications such as smart labels, decorative and animated posters, and active clothing. They are also targeting large area products, flexible products, non-flat shaped products such as flexible displays and sensor walls [6].

Printed electronics can further be subdivided into two main categories on the basis of requirement of material and the printing approach followed for the processing of the functional materials. Functional inks can either be conductors, dielectrics, resistors or semiconductors depending on the requirement in the device or component. Printing process is applied according to the pattern's resolution, robustness, and dimensional requirements of the device or component.

2.2. Printing Technologies:

Printed Electronics is an additive processing method, whereby a functional material is deposited in a controlled manner to print the desired pattern without wasting the material. Graphical patterns (structures or images) are transferred directly in one step by using printing process in general by supplying image carrier with colloidal solutions (dye or pigments) onto a substrate as it travels through a printhead. Printing technologies can broadly be divided into two main sections depending on the operation procedure of the technique and image transfer i.e. Analog printing and Digital printing. In analog printing, a gravure cylinder, a press plate and /or a screen can be an image carrier; in digital printing, the image is stored in digital format and must be generated at each output. Here the image carrier becomes a “virtual press plate” by programming the moving path of a printhead or the substrate holder in a specific pattern. Classifications of well-established printing technologies are shown in the Figure 2.2. Each type of printing technique has its own benefits and limitations when it comes to application in manufacture of simple and even more complex structures. Operating mechanism of each printing technique requires a specific set of properties and only by keeping those properties an acceptable operating envelope can be achieved for a specific pattern with strict resolution requirements. The attraction of printing technology for the fabrication of electronics mainly results from the possibility to prepare stacks of micro-structured layers (and thereby thin-film devices) in a much more simple and cost-effective way. Beside this, also the possibility to implement new or improved functionalities (e.g. mechanical flexibility) plays a very important role. The selection of used printing methods is determined by requirements concerning printed layers, by properties of printed materials as well as economic and technical considerations in terms of printed products. Conceptually to most people, printing is only about “inks” and “ paper”, but it is actually not limited to any particular “ ink” or “ substrate”, especially when patterning of electronic functional materials is involved [7-9].

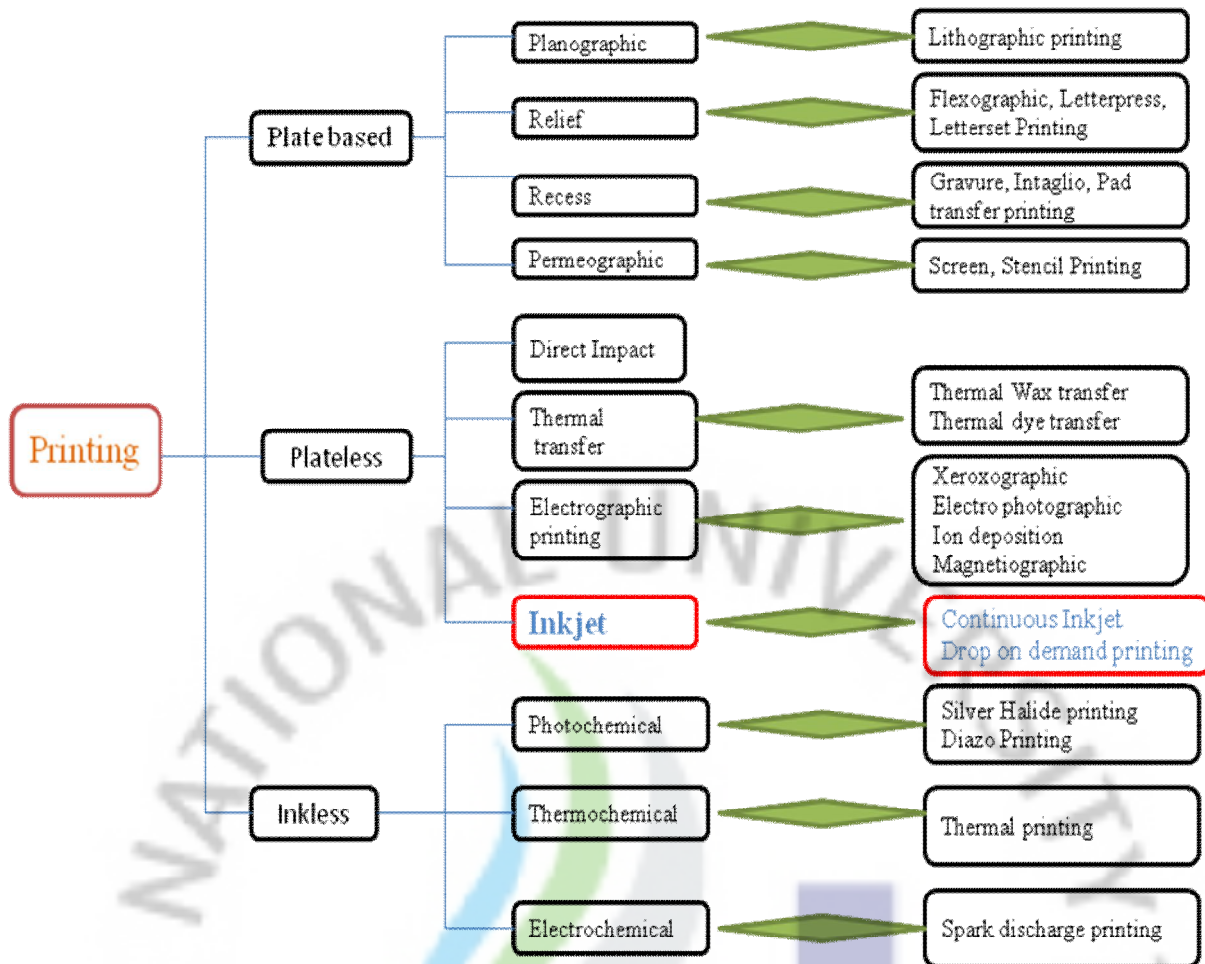

Fig. 2.2. Different Printing Techniques and approaches followed

2.3. Key Printing Technologies:

As mentioned above the key printing technologies can be divided into Contact (analog) and non-contact (digital) approaches. Non-contact printing mainly comes under Inkjet technology while contact printing is widely used in paper and print media. Table 2.1 summarizes some of the main printing technologies currently involved in competition for the manufacture of printed and flexible electronics.

Table 2.1 Key Contact and non-contact printing techniques	
Contact printing Technology	Non-Contact printing technology
Screen printing	Aerosol Inkjet Printing
Offset printing	Thermal Inkjet Printing
Flexography printing	Piezoelectric Inkjet Printing
Gravure Printing	Electrostatic Inkjet Printing
Pad printing	Acoustic Inkjet Printing

The most common feature of all printing technologies is the same state of material, i.e. solution based materials can only be processed. Printed electronics, in contrast, specifies the

process, and can utilize efficiently any solution-based material, including organic semiconductors, inorganic semiconductors, metallic conductors, nanoparticles, nanotubes etc.

2.4. Contact printing technologies.

Contact printing technologies involve the direct contact of the printing source and substrate. Various contact printing techniques developed so far including Screen printing, Offset printing, Flexographic printing, Gravure printing, Pad and Micro-contact printing. Screen printing is a fairly simple process involving three basic components; ink is pushed through a screen by a squeegee. Screens are available in a wide range of meshes. The method by which image is to be printed is created on the screen relatively simple and inexpensive. For printed electronics the ability of a screen press to apply a wide range of ink thicknesses is critical, because complex products require densities that are rarely uniform. Also the resolution which can be achieved by using screen printing is more than 80 μm and cannot be applied in areas where thicknesses of the order of few nano meters are required. To mention a few, the printing speed, angle and geometry of the squeegee, distance between the screen and the substrate, mesh material, etc. are all variables that can affect the image quality [10].

Offset printing is a commonly used printing technique where the inked image is transferred (or "offset") from a plate to a rubber blanket, then to the printing surface. When used in combination with the lithographic, which is based on the repulsion of oil and water the offset technique employs a flat (Planographic) image carrier on which the image to be printed obtains ink from ink rollers, while the non-printing area attracts a water-based film (called "fountain solution"), keeping the non-printing areas ink-free. Have the benefit of quick and easy production of printing plates. Longer printing plate life than on direct litho presses because there is no direct contact between the plate and the printing surface. Slightly inferior image quality compared to other printing techniques. Propensity for anodized aluminum printing plates to become sensitive (due to chemical oxidation) and print in non-image/background areas when developed plates are not cared for properly. Time and cost associated with producing plates and printing press setup. As a result, very small quantity of printing.

Flexography uses flexible printing plates made of rubber or plastic those are frequently used for printing on plastic, foil, acetate film, brown paper, and other materials used in packaging. The inked plates with a slightly raised image are rotated on a cylinder which transfers the image to the substrate. Flexography uses fast-drying inks, is a high-speed print process, can print on many types of absorbent and non-absorbent materials, and can print continuous patterns (such as for gift-wrap and wallpaper). Also known as flexographic

printing or flexo, some typical applications for flexography are paper and plastic bags, milk cartons, disposable cups, and candy bar wrappers. Flexographic printing may also be used for envelopes, labels, and newspapers.

Gravure transfers ink from small wells or cells that are engraved into the surface of the cylinder. Working principle of gravure printing is to transfer ink from reservoir to rotogravure cylinder. The vast majority of gravure presses print on rolls (also known as webs) of paper rather than sheets of paper. Image is engraved on rotogravure plate. Doctor blade removes extra ink. Substrate runs between rotogravure plate and impression cylinder. Surface of substrate must be smooth for successful printing. Reverse of flexographic printing in terms of wetting ink on printing plate.

Pad printing is a printing process that can transfer a 2-D image onto a 3-D object. This is accomplished using an indirect offset (gravure) printing process that involves an image being transferred from the printing plate via a silicone pad onto a substrate (surface to be printed). Pad printing is used for printing on otherwise impossible products in many industries including medical, automotive, promotional, apparel, electronics, appliances, sports equipment and toys. It can also be used to deposit functional materials such as conductive inks, adhesives, dyes, and lubricants [11].

2.5. Non-Contact or Inkjet printing technologies:

Inkjet printing is a digital non-contact material-depositing method that offers precise droplet placement and volume accuracy as well as the possibility to print material onto topographic surfaces. Inkjet printing can be used in electronics packaging as interconnections between electronic components. Digital printing is a modern technology compared to the other printing processes, with its birth and growth going hand in hand with that of the microcomputer. A broad range of technologies and imaging methods are included under the umbrella of digital printing. Its primary distinction from more traditional printing is that the imaging is directly controlled by an electronic device and therefore does not require any other physical links (such as plates or screens) between the computer image and the print. This provides digital technology its primary advantage in that each individual print can have a different image giving the process flexibility. This inherent feature of digital printing allows fast prototyping; short runs and quick job turn around. Among all printing processes inkjet is the most promising technology due its versatility and broad range of applications to solution based organic and inorganic materials. It is digital non impact additive process, applicable to all kinds of substrates (rigid or flexible, rough or smooth surfaces, 3D surfaces), accurate, high resolution, high speed and possible for mass customization. Almost all of contact

printing method utilizes the roll-to-roll technology to transfer the base pattern on the substrate. Whereas the registration control in case of tight tolerances can be of challenge since the printing pressure is high with high web velocity and elastic nature of the flexible substrate makes it even more difficult. However the resulting product is cheaper than non-contact printing method due to the high printing speed. Inkjet printing has several advantages over contact based printing technologies. It can be applied for both drop-on-demand and intact jet applications where a specific amount of material is needed to be deposited and avoiding material wastage on a large scale [12].

Position specific deposition and material efficient manufacturing features of inkjet technology distinguishes it from other fabrication techniques in a way to define a separate active device or layer with reduced resolution. There are several ways to create the droplets and continuous jets to control where the jetted material should land on the substrate, depending on the requirement for the functionality and role of the deposited material in the device. The two main principles in the inkjet technology followed are Continuous Inkjet and Drop on Demand (DoD).

a. Continuous (Intact) Inkjet Printing,

Continuous inkjet printing is the most suitable direct writing approach of colloidal solutions for low resolution patterning. Continuous inkjet is mainly an industrially applied technique mostly used for marking and coding of products and packages. The main advantages of continuous inkjet are its speed and the high velocity of the jet that enables it to travel a larger distance to the substrate. The fact that there is a continuous flow of ink through the nozzles minimizes the risk of clogging them. Whereas the printing speed is fast as compared to the drop-on-demand process and is suitable for high printing throughput. However the equipment cost is high as compared with the on-demand inkjet printing setup.

b. Drop on Demand Printing

Drop on Demand printers only ejects drops required for printing. By positioning the substrate and print head the drop placement is controlled, and precise patterning can be obtained. Drop-on-demand inkjet printing provides more flexibility in terms of the ink deposition on the substrate and provides higher accuracy than the continuous printing. Various printing technologies under the Inkjet technology are shown in Fig. 2.3 as below,

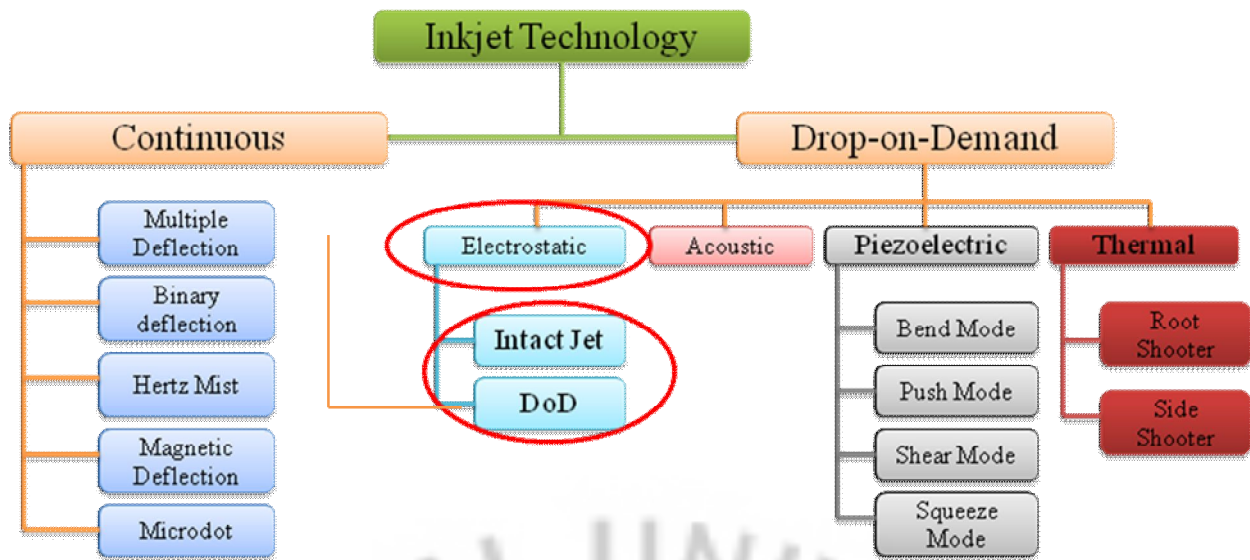

Fig. 2.3. Different Non-Contact or Inkjet Technologies

According to the distribution based on the operating procedures and different ink ejection mechanisms, drop-on-demand is further divided into thermal, piezo, acoustic and electrostatic inkjet systems. All these systems are differentiated according to the actuation mechanism of the solution into droplets. In the following discussion all these inkjet systems, basic operating principles and system designs are discussed in full detail.

2.5.1. Thermal Inkjet:

In thermal inkjet drop-on-demand printing system, drop is only ejected when required for printing. There are no unneeded drops to collect and recycle. Thermal inkjet uses tiny thin film resistor located within each nozzle to boil a thin film of ink. A narrow voltage pulse heats the resistor to above 300 °C in a few microseconds producing a vapor bubble in the ink. The bubble expands and drives a droplet of ink out of the nozzle. As the bubble collapse it draws fresh ink into the nozzle firing chamber for the next shot. There are no moving parts other than the ink itself. Drop firing frequencies as high as 18 kHz are possible with this approach. It is important to note that a very small amount of liquid is boiled and temperature of the ejected drop itself is in equilibrium with the printhead and not particularly hot [13].

2.5.2. Piezoelectric Inkjet System:

Piezoelectric drop-on-demand system differs from thermal inkjet in that a vibration plate connected to a vibrating piezoelectric crystal provides energy for drop generation. When the piezo crystal pushes the plate fluid is displaced and a droplet is forced out of the nozzle. When the crystal pulls on the plate, fresh ink is drawn into the firing chamber. Most commercial and industrial ink jet printers use a piezoelectric material in an ink-filled chamber behind each nozzle instead of a heating element. When a voltage is applied, the piezoelectric material changes shape or size, which generates a pressure pulse in the fluid forcing a droplet

of ink from the nozzle. This is essentially the same mechanism as the thermal inkjet but generates the pressure pulse using a different physical principle. Piezoelectric (also called Piezo) inkjet allows a wider variety of inks than thermal or continuous inkjet but the print heads are more expensive. Requirements of this application are a long service life, a relatively large gap between the print head and the substrate, and low operating costs [14].

Various modes of piezo-based inkjet systems have been developed depending on the structure of the head design and diaphragm placement.

2.5.2 (a). Squeeze mode Piezo-inkjet:

In this mode electric charge deforms piezoceramic so that it squeezes the ink within the tube forcing it out through the nozzle end. A squeeze-mode ink-jet can be designed with a thin tube of Piezo-ceramic surrounding a glass nozzle or with a Piezo-ceramic tube cast in plastic that encloses the ink channel. When a voltage is applied on the piezoelectric material, the ink chamber is squeezed and a drop is forced out of a nozzle [14].

2.5.2 (b). Bend Mode Piezo-inkjet:

In Piezoelectric bend mode print heads, piezo ceramic plates are electrically excited which further expand placing pressure on the ink forcing some through the nozzle and thus forming ink droplets. The electrical field between its electrodes is in parallel with the piezoplate polarization. The piezo plates are bonded with the print head diaphragm which is opposite the nozzle plate [14].

2.5.2 (c). Push mode Piezo-inkjet

Push mode is similar to bend mode, electrical field between its electrodes is parallel with the piezoplate polarization, the piezoceramic pushes against a transducer foot which places pressure on the ink eject droplets. It is relatively high energy process which ejects droplets which are more elongated and may form satellite droplets; however they usually compromise image quality. In Push-mode design the piezoelectric material is stacked as a rod. As the piezoceramic rods expand, they push against ink to eject the droplets. The electric field generated between the electrodes is in parallel with the polarization of the piezomaterial and since the piezo-ceramic rod is just placed over the ink chamber it provides the necessary ejection force to generate droplet [14].

2.5.2 (d). Shear mode piezo-inkjet:

Shear mode print heads use an electric field perpendicular to the polarization of the piezoelectric (pzt) driver. Electric charge causes a shearing action in the distortion of the pzt piezoplates against the ink causing the ink to eject from the nozzle opening in drops. The basic operation of a shear mode type inkjet head utilizes the shear mode deformation force of

piezoelectric elements. Voltage is applied to the piezoelectric walls on both sides of the ink pressure chamber due to this deformation occurs to both sides of the ink pressure chamber. When the reverse polarity voltage is applied to the piezo walls they move apart and ink flows inside the chamber due to the displaced volume. A reverse electric field is generated, which makes the nozzle walls curve in the closing direction, delivering ink drops and finally the nozzle walls are returned to initial position [14].

2.5.3. Electrohydrodynamic Inkjet Printing

In electrohydrodynamic inkjet system the driving force for ejection of droplets or intact jets are the application of very high voltages and generating an electric field between solution and a counter electrode. Electrohydrodynamic jet (e-jet) printing exploits electric fields, rather than thermal or acoustic energy, to generate the liquid flows necessary for printing solutions to a substrate. Colloidal solution with conductivity in the range of semiconductors is delivered through Teflon tubing to the nozzle head and a metallic electrode for charging of the fluid is used. When a nozzle is filled with an ink without applying electric field, a hemispherical meniscus pendant at the nozzle tip is formed by the surface tension at the interface between the liquid and air. As electric field is applied between the ink and a substrate located on a conducting plate, mobile ions with the same polarities are accumulated near the surface of the liquid meniscus. Maxwell electrical stress is induced by the coulombic repulsion between the ions, and this electrostatic force deforms the hemispherical meniscus to a liquid cone, as the electric field strength increases. Also, capillary pressure, which is caused by the surface tension and curvature of the conical apex, is applied to the opposite direction of the electrostatic force during this deformation. Therefore the geometry of the cone (cone angle) can be determined by the balance between the applied electrostatic force and capillary pressure, and is known as Taylor cone [15].

When the electrostatic stress exceeds the capillary pressure, single or multiple jets with very thin diameters can be ejected from the apex of the cone to expel the surface charges (Rayleigh limit), and then printed on the substrate. Depending on the overall stress balance, nozzle geometry, and ink properties, this jet ejection can be operated in various types: pulsating jet mode, stable jet mode, multiple jet ejection, and electrospray. Due to the high instability of the charged jets, this electrohydrodynamic jet printing has been commercially applied only on the limited area, where sophisticated controls of the jetting modes are not highly demanded, such as electrospray ionization mass spectroscopy (ESI-MS) and electrospray atomization. Although this technique was explored in research levels for the inkjet printing applications in the graphic arts, the printing resolution is coarse (dot size ≥ 20

μm in diameters using nozzles $\geq 50 \mu\text{m}$ in diameters) and jetting rate is typically slower than the conventional thermal/piezoelectric inkjet methods [16].

A counter metallic electrode is used as a ground for complete system design below substrate. Different approaches are followed for placing the counter electrodes as shown in the Fig. 2.4 below.

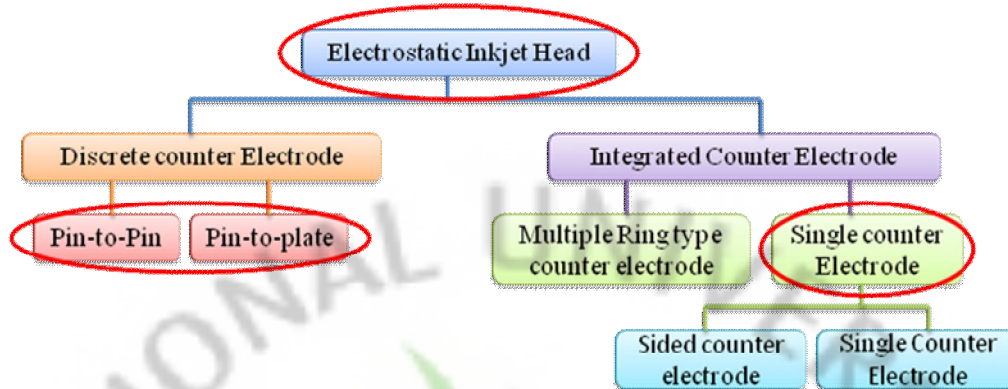

Fig.2.4. Electrostatic inkjet classification based on different ground configurations

In an electric field, the pendant droplet is deformed in a cone with a thin jet emanating from the apex of the cone as shown in Fig 2.5 (a & b). This transition commonly known as cone jet transition is exploited here to produce a large ‘neck-down’ ratio between the orifice and the jet. This lead to a high resolution direct printing technique capable of deposition on large area surface on a micron or submicron scales using either colloidal suspensions or homogeneous liquids. Electrohydrodynamic forces are used to produce a thin filament from a relatively large nozzle. Such electrohydrodynamic forces stem from the inhomogeneity of electrical conductivity and dielectric constant within or across the phase boundaries which induces electrical charges along the fluid interface. While surface tension tends to keep the pendant droplet in spherical shape, the repulsion between surface charges acts against the surface tension force to deform the sphere into cone. At sufficiently large field strength, a thin jet emanates from the conical apex. The intact jet then directly writes on the substrate surface to generate two-dimensional patterns. The main advantage of employing the cone-jet transition as the jetting mechanism over the conventional pressure-driven ejection in the ink jet printing is its large ‘neck-down’ ratio between the diameter of the nozzle and the jet [17].

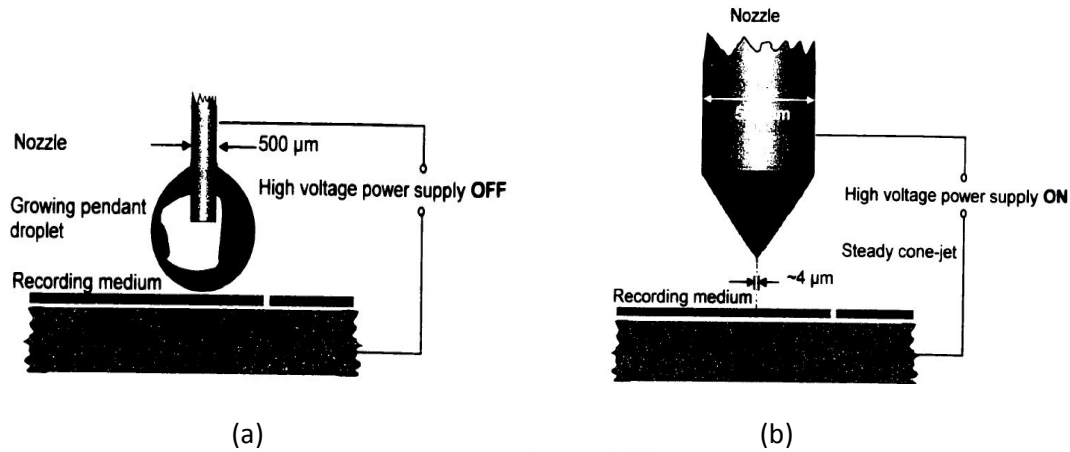

Fig.2.5. a) Pendant drop when voltage is not applied. b) Cone jet when voltage is applied
2.5.3 (a). Electrohydrodynamic printing principle and nozzle head setup:

In electrohydrodynamic inkjet printing system the fluid is electrified and ejected through the nozzle with the help of electrical forces by applying high voltage [18]. Electric charges are effective at the surface of the liquid meniscus, and an electric stress stretches the meniscus. At a certain value of applied voltage the meniscus of the liquid is deformed into a sharp cone and charged liquid droplets are ejected from the nozzle [19]. Fig.2.6 (a & b) show the effective forces and behavior of the liquid meniscus before and after applying voltage.

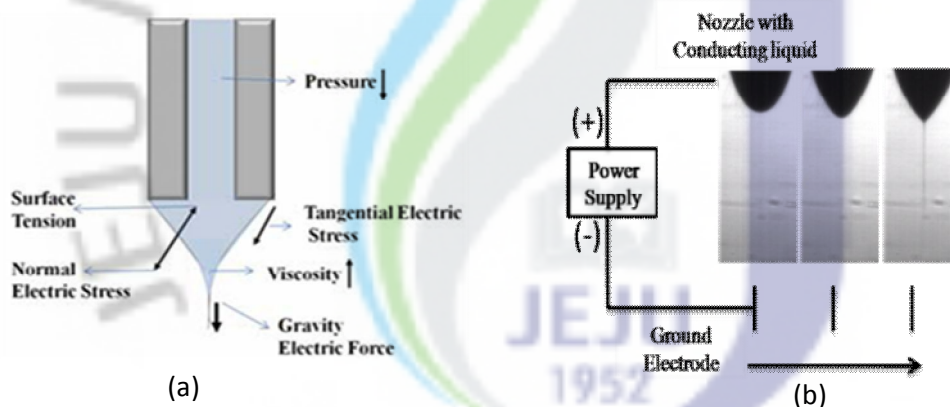

Fig. 2.6. a) Effective forces at the Meniscus, b) Emission of jets upon application of voltage

The effective forces acting at the meniscus consist of gravitational force, surface tension, viscous, electric and the flow rate pressure. As soon as the electric forces accompanied by flow pressure exceed the surface tension forces, ejection of droplets begin. For ejection, the liquid meniscus is affected mainly by two forces: an electric field force and the surface tension force [20]. Various models have been presented in literature and relationships are found for calculating theoretically the optimum parameters. Based on the configuration of the electrohydrodynamic inkjet system, Loeb et al. developed an equation for electric field at the tip of the capillary [21].

$$E_c = \frac{2V_c}{r \ln\left(\frac{4d}{r}\right)} \quad (2.1)$$

Here E_c is the electric field at the capillary, V_c is potential at the capillary, r is the capillary outer radius, and d is the distance between the capillary tip and counter electrode. To solve the electrical potentials required, useful equation derived by Smith [22], can be used:

$$E_0 = \frac{2\gamma \cos \theta}{\epsilon_0 r} \quad (2.2)$$

Here E_0 is the onset electric field, γ the surface tension of the liquid, θ is angle of the Taylor cone, ϵ_0 is the permittivity of vacuum and r is the radius of the capillary. By combining the equation of the onset electric field with that of the capillary electric field by the configuration, the required onset potential at which the cone jet starts can be estimated as, [23]

$$V_0 = \sqrt{\frac{r\gamma \cos \theta}{2\epsilon_0}} \ln\left(\frac{4d}{r}\right) \quad (2.3)$$

$$V_0 = 2 \times 10^5 \sqrt{r\gamma} \ln\left(\frac{4d}{r}\right) \quad (2.4)$$

Permittivity of free space is $J^{-1} C^2 m^{-1}$ while θ is taken the Taylor angle i.e. 49.3° [24]. The above mentioned equation can be used to find the approximate value of onset electric potential.

2.5.3 (b). Different modes of Electrohydrodynamic inkjet printing:

The two main potential areas of application for EHD i.e. in printing approach the distance is kept very close to the substrate so that the disintegration of the droplets or jets into many small droplets due to columbic repulsions of the same charges residing on the droplets is minimized. While in electrospray the standoff is high in order to provide enough time for disintegration into fine droplets and deposited in the form of layers due to the wide spreading of the jet or droplets during the time of flight. Although it is well known that the atomization process is governed by the physical properties of liquid. The mode of electrohydrodynamic spraying is the way the liquid is dispersed into droplets, and is characterized by two criteria:

1. The geometrical form of the liquid at the outlet of the capillary (drop, spindle, jet),
2. The mechanism of the disintegration of the jet into droplets (type of instability).

The spraying modes can be divided into two groups. Into the first group are included the modes in which only fragments of liquid are ejected from the capillary directly. This group comprises: the dripping mode, microdripping mode, spindle mode, multi-spindle mode, and ramified-meniscus mode. Into the second group are included the modes in which the liquid issues a capillary in the form of a long continuous jet which disintegrates into droplets only in some distance, usually a few mm, from the outlet of the capillary. The jet can be stable or move in a certain manner. This group includes cone-jet mode, precession mode, oscillating-jet mode, multijet mode and ramified-jet mode.

The dripping mode of EHD spraying does not differ significantly from the dripping, when no voltage is applied to the capillary. In microdripping mode, liquid at the outlet of a capillary forms a stable meniscus, at the end of which a small, much smaller than the capillary diameter, droplet is formed. In the spindle mode, the meniscus of liquid elongates in the direction of electric field as a thick jet and detaches as a vast spindle-like fragment of liquid. For liquids of high viscosity a multi-spindle mode of spraying has been recorded. The droplets' generation is similar to the spindle mode, but spindles are only emitted periodically from distinct points at the circumference of the capillary, usually in the form of a short spindle-like jet, one piece of liquid at an instant. After detachment the piece of liquid can disintegrate into a few smaller droplets. A few narrow streams around the capillary can be then distinguished in continuous illumination. In the cone-jet mode the liquid forms a regular, axisymmetric cone with a thin jet ($<100\ \mu\text{m}$ in diameter, in most of the cases) at its apex. In the oscillating-jet mode the continuous jet issues from the tip of the cone and changes its position (oscillates) in one plane with the capillary axis. The cone at the outlet of the capillary transits smoothly to a jet. In the precession mode the liquid escapes the capillary in the form of a skewed cone which changes at its apex into a thin jet of diameter smaller than $100\ \mu\text{m}$. Both the cone and the jet rotate regularly round the capillary axis, assuming a form of a fragment of a spiral. In the multi-jet mode the meniscus becomes flat with small cones at distinct points at the circumference of the capillary, from which fine jets of liquid are ejected. The diameter of the jets is smaller than a few of tenth of micrometers [25]. In all these modes of EHD, the most important is the stable cone jet which can be exploited for both printing and uniform electrospray deposition of colloidal solutions for microfabrication of devices.









Pieces of liquid		Liquid jets	
Dripping mode		Cone-jet mode	
Microdripping mode		Oscillating-jet mode	
Spindle mode		Precession mode	
Multispindle mode		Multijet mode	
Ramified-meniscus mode		Ramified-jet mode	

Fig. 2.7. Different modes of EHD

2.5.3 (c). Comparison of conventional drop-on-demand and EHD inkjet system:

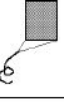
The above mentioned conventional thermal/piezoelectric printers are useful for many applications, the reduced resolution of the printed patterns, as defined by the narrowest lines or smallest spacings that can be printed reproducibly with no assist features, is 10~30 μm in current stage, and too large for potential areas. This challenge is caused by (i) limitation to reduce nozzle sizes below micron scales, (ii) generation of droplets bigger than the nozzle sizes, and (iii) the statistic deviation of jet trajectory. Prominent inkjet printing systems division based on the operating mode and actuation mechanism of drop ejection are thermal inkjet, piezo inkjet and electrostatic inkjet systems. The first two can only eject tiny droplets upon operation and deposited only on a specific spots on the substrate. A continuous line can be drawn by manipulating the process parameters, i.e. ejection frequency, substrate speed and multiple passes etc. But the case is entirely different in the new emerging EHD inkjet system, as it can operate both in drop-on-demand mode as well as in continuous jet mode for devices where continuous and uniform lines are desired. Table. 2.2 below summarizes the main advantages and disadvantages of prominent inkjet systems.

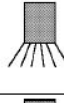
	Thermal inkjet	Piezo inkjet	Electrostatic
Principle	Drop-on-Demand Drop generated only when needed. Heater generates a bubble that forces out an ink drop out of nozzle orifice.	Drop-on-Demand Piezoelectric crystal generates a pressure pulse that forces an ink drop out of the nozzle orifice.	Drop-on-Demand and continuous jet. Ejection of droplets and jet in the presence of an electric field generated.
Benefits	Drop placement at specific spot by eliminating conventional lithography.	Only acoustic pressure affecting ink during drop formation, durable print head. Applicable to a variety of inks, Organic material ejection easy.	High speed, Applicable to colloidal and homogenous liquids, Sub-micron resolution, accurate, minimum drop size, easy process setups, simple structure
Drawbacks and Issues	Ink sedimentation. Low speed. Short print head lifetime. Ink exposed to high temperature, very difficult with most of organic materials. Clogging of the nozzles.	Nozzle drying, Drop on Demand, Not feasible for versatile inks, Big droplet formation than the nozzle orifice size,	Stabilization and control of trajectory of submicron jets, synchronization of the jet speed with substrate speed to avoid accumulation.
Schematic of the system operation			

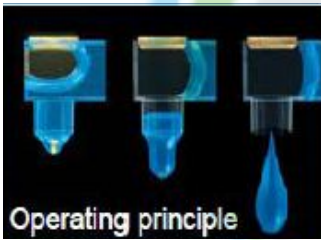
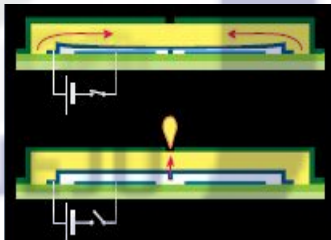
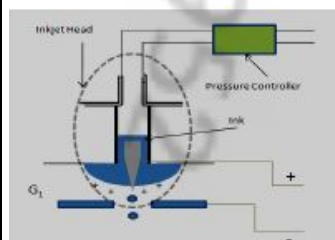
2.6. Applications:

Applications of drop-on-demand inkjet ejectors is unlimited and in various field they are mentioned as below (Lee 2003)

Applications in Applied Science

- Combinatorial Chemistry
- Micro-mixing
- Automated Micro-titration
- Matrix Assisted Laser Desorption Ionization Time Of Flight (MALDI TOF) Spectroscopy Sample Loading
- Loading and Dispensing Reagents from Micro-reactors
- Gas Flow Visualization

Applications in Biotechnology

- Cell Sorting

- DNA Microarrays
 - DNA Synthesis
 - Drug Discovery
 - Medical Therapeutics
- Applications in Manufacturing & Engineering**

- Optics
- Droplet-Based Manufacturing
- Inkjet Soldering
- Precision Fluid Deposition
- Thin Film Coating
- Document Security
- Integrated Circuit (IC) Manufacturing
- IC Manufacturing — Photo resist Deposition
- IC Manufacturing — Conductor and Insulating Dielectric Deposition
- Manufacturing — Depositing Sensing and Actuating Compounds

References:

- [1] Singh M, Haverinen H M, Dhagat P and Jabbour, Inkjet Printing—Process and its Applications, *Adv. Mater.* 2010, 22, 673–685, DOI: 10.1002/adma.200901141
- [2] Jianglong Chen, Novel Patterning Techniques for Manufacturing Organic and Nanostructures Electronics, PhD Thesis, MIT, 2007
- [3] Printed Electronics, ObservatoryNANO, ICT Sector Focus Report, April 2010.
- [4] Esa Kunnari, Jani Valkama, Marika Keskinen and Pauliina Mansikkamäki, Environmental evaluation of new technology: printed electronics case study, *Journal of Cleaner Production* Volume 17, Issue 9, June 2009, Pages 791-799
- [5] Zhiyong Fan, Johnny C. Ho, Toshitake Takahashi, Roie Yerushalmi, Kuniharu Takei, Alexandra C. Ford, Yu-Lun Chueh, and Ali Javey, Toward the Development of Printable Nanowire Electronics and Sensors, *Adv. Mater.* 2009, 21, 3730–3743
- [6] Paul Calvert, Inkjet Printing for Materials and Devices, *Chem. Mater.* 2001, 13, 3299-3305
- [7] ISO TC130: Graphic Technology/WGI: Terminology International organization for Standardization Geneva, Switzerland
- [8] N.Ohta, M.Rosen, *Color Desktop Printing Technology*, CRC Press Boca Raton(2006)

- [9] Jiang Chen, PhD Thesis, Novel Patterning Techniques for Manufacturing Organic & Nanostructured Electronics, PhD Thesis, MIT, 2007
- [10] Radoslav Parashkov, Eike Becker, Thomas Riedl, Hans-Hermann Johannes, and Wolfgang Kowalsky, Large Area Electronics Using Printing Methods, PROCEEDINGS OF THE IEEE, VOL. 93, NO. 7, JULY 2005.
- [11] Printed Electronics, ICT Sector Focus Report, ObservatoryNANO, April 2010
- [12] Daniel R. Gamota, Paul Brazis, Krishna Kalyanasundaram and Jie Zhang, Printed Organic and Molecular Electronics, Kluwer Academic Pub, P, 319
- [13] Todd A. Cleland, PhD Thesis, Printed Electronics: The next inkjet revolution, MIT, 2003
- [14] Herman Wijshoff, The dynamics of the piezo inkjet printhead operation, Physics Reports 491 (2010) 77_177
- [15] A.M Ganan Calvo. J. Aerosol Sci. 30, 863-872 (1999)
- [16] Jang-Ung Park, PhD Thesis, High-Resolution Electrohydrodynamic Jet Printing Methods For Applications In Electronics and Biotechnology, UIUC, 2009
- [17]. Hak Fei Poon, PhD Thesis, Electrohydrodynamic Printing, Princeton University, 2002
- [18] A. Jaworek, A.T. Sobczyk, A.Krupa, M. Lackowski, and T. Czech: 1st National conference of Nano and Micro Mechanics (KKNM08), Krasieczyn, 2008, p. 63.
- [19] A. Jaworek, A.T. Sobczyk: Journal of Electrostatics 66 (2008) 197
- [20] Kyung Hyun Choi, Ahsan Rahman, J. B. Ko, Asif Rehmani, Adnan Ali, Y. D. Doh and D. S. Kim: Int J Adv Manuf Technol: DOI, 10.1007/s00170-009-2255-9
- [21] L.B. Loeb, A.F. Kip, G.G. Hudson and W.H. Bennet: Physics Review (1941), p.714- 722
- [22] D.P.H Smith: IEE Transactions on Industry Applications (1986), P. 527-535
- [23] Joonwan Kim, "A Study on micro Patterning Method Using Electrically Controlled Nano-particle Deposition" Ph.D Thesis, The University of Tokyo, 2006
- [24] "Disintegration of water drops in electric field" proc. R. Soc. London, Ser. A 280,283
- [25] Jaworek A, Krupa A, Main Modes of Electrohydrodynamic Spraying of Liquids, Third International Conference on Multiphase Flow, ICMF'98, Lyon, France, June 8-12, 1998

Chapter # 3

Printed Thin Film Transistors

The first inorganic thin film transistor (TFT) was demonstrated by Wiemer in 1961 using cadmium sulphide as the active layer material. However hydrogenated amorphous silicon (a-Si:H) and polysilicon (poly-Si) TFTs have become devices of choice that found many important applications in liquid crystal displays, sensors, imagers and consumer electronics. Low temperature polysilicon TFTs will compete with solution processed organic and inorganic printable materials for applications in large-area electronic circuits on flexible substrates and electrotexiles. Printed thin film field-effect transistors (TFTs) are particularly interesting as their fabrication processes are much less complex compared with conventional Si technology, which involves high-temperature and high-vacuum deposition processes and sophisticated photolithographic patterning methods. In general, low-temperature deposition and solution processing can replace the more complicated processes involved in conventional Si technology. In addition, the mechanical flexibility of thin film materials makes them naturally compatible with plastic substrates for lightweight and foldable products. Since the report of the first organic field-effect transistor in 1986, there has been great progress in both the materials' performance and development of new fabrication techniques. OTFTs have already been demonstrated in applications such as electronic paper, sensors, and memory devices including radio frequency identification cards (RFIDs). Upon successful application of OTFTs in many electronic devices, their slow speed and degradation due to environmental affects is compelling academic and industrial researchers to make way for alternative, i.e. solution processed inorganic materials [1].

Printed thin-film transistors (TFTs) have gained attention for their potential to reduce the cost of fabricating large-area electronics. Solution processed materials can be deposited from solution and therefore allow device patterning by direct marking techniques. Among all commercialized printing techniques, inkjet printing is particularly attractive process because it is low cost, applicable to large-area processing, compatible with variety of substrates, and can be adapted to high-throughput manufacturing processes, such as roll-to-roll printing methods. Jet printing also provides a drop-on-demand digital lithographic process without the need for physical masks. While many of the patterning techniques under development for TFTs are subtractive in nature as more material is required to define a pattern than is in the final device. Jet printing is additive and material is only applied where it is needed, which decreases materials cost and environmental impact [2].

3.1 Introduction to thin film transistor and its basic structure:

The Thin Film Transistor (TFT) is special kind of field-effect transistors made by the deposition of thin films of the different materials that make up the transistor. A semiconducting layer is in contact with a source and a drain electrode of width W , which are situated at a distance L from each other. The semiconducting layer is separated from a third gate electrode by an insulating layer, the gate dielectric. The semiconducting layer can be sputtered, vacuum sublimed, spin coated, spray deposited or dropcast depending on the material. The gate electrode is highly conductive and can be made using doped inorganic semiconductors, metals or conductive polymers/oxides. For the dielectric it is common to use inorganic insulators such as SiO_2 (thermally grown or sputtered), Al_2O_3 and SiN_x or polymeric insulators, such as poly methyl methacrylate (PMMA), poly 4-vinylphenol (PVP) or benzocyclobutene (BCB) amongst others. The drain and source electrodes can also be metals or conducting polymers, such as PEDOT:PSS, which are used to exploit the advantages of inkjet printing [3]. It is a three-terminal device, in which a voltage applied to a gate electrode controls current flow between a source and drain electrode under an imposed bias. A basic schematic is shown in Fig. 3.1, where L is the channel length, the distance between the conductive contacts (source and drain) while W is the channel width. It is a voltage controlled device, and the control of source-drain current in FETs via a gate terminal has resulted in their widespread use as switches. Their utility in this capacity is gauged by several key measures of their performance. The mobility, μ , describes how easily charge carriers can move within the active layer under the influence of an electric field and is, therefore, directly related to the switching speed of the device. This parameter can be extracted from current-voltage measurements, and would ideally be as large as possible. Typical values range from 0.1-1 $\text{cm}^2/\text{V}\cdot\text{s}$ for amorphous-Si (a-Si) devices, with the best organic materials achieving mobilities of 1-10 $\text{cm}^2/\text{V}\cdot\text{s}$. The on/off ratio, defined as the ratio of the current in the 'on' and 'off' states, is indicative of the switching performance of TFTs. A low off current is desired to eliminate leakage while in the inactive state [4].

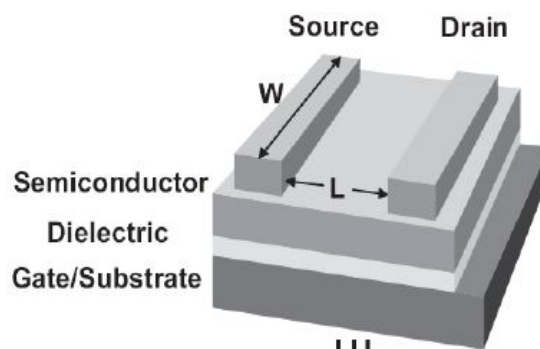

Fig. 3.1 Basic schematic of thin film transistor

Four possible TFT device structures followed by researcher are shown in Fig. 3.2. As evident from Fig. 3.2, devices can be either staggered or coplanar. In a coplanar configuration, as shown in Figs. 3.2b and 3.2d, the source and drain contacts and the insulator are on the same side of the semiconductor. In such an arrangement, the source-drain contacts are in direct contact with the induced channel. In a staggered configuration, as shown in Figs. 3.2a and 3.2c, the source and drain contacts are on the opposite side of the semiconductor from the insulator; thus, there is no direct connection to the induced channel. However, the contact area is very large when a staggered structure is used [5].

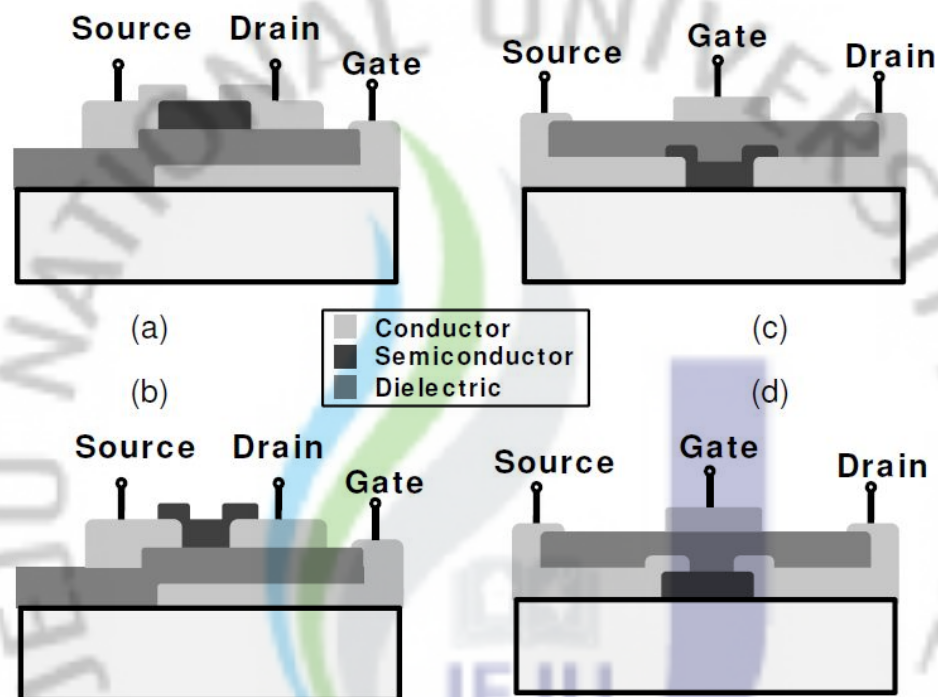

Fig. 3.2: Four general thin-film transistor configurations, including, (a) staggered bottom-gate, (b) coplanar bottom-gate, (c) staggered top-gate, (d) coplanar top-gate

In addition to coplanar and staggered configurations, TFTs can be classified as either bottom-gate or top-gate devices. A bottom-gate TFT, which is sometimes referred to as an inverted TFT, has the gate insulator and gate electrode located beneath the semiconductor, as shown in Figs. 3.2a and 3.2b. The top surface of a bottom-gate TFT is exposed to air or is passivated by coating the top surface with a protective layer. A top-gate TFT, as shown in Figs. 3.2c and 3.2d, has the gate and insulator located on top of the semiconductor. In a top-gate device, the semiconductor is covered by a gate insulator so that the top surface is inherently passivated.

Process integration-related issues can also motivate the use of different structures. In the coplanar top-gate structure, the semiconductor is deposited first. Therefore, the maximum

semiconductor processing temperature is limited only by the semiconductor and the substrate.

3.2. Basic Device Operation:

Device operation and the drain current of TFTs are often described using terminology and expressions developed for crystalline silicon MOSFETs. While this is done for convenience, there are several important features that make TFTs distinct from MOSFETs. Importantly TFTs differ from MOSFETs in their device operation. MOSFETs operate as depletion or inversion mode devices, while TFTs operate as accumulation mode devices.

Fig 3.3 shows the cross section of a top-contact TFT with external voltage sources shown to indicate biasing.

The biasing corresponds to an accumulation mode n-channel TFT. The solid circles represent negative charge carriers. Injected carriers first contribute first to filling trap states in the energy gap between the relevant carrier conduction levels. As the gate–source voltage and carrier injection level increases, the trap states in the energy gap are getting filled and the Fermi level of the active layer in the region nearest the gate insulator approaches the mobility edge. This condition largely determines the threshold voltage of the device. Above threshold, as small change in the gate-source voltage result in a large increase in drain current. Fig 3.3a shows the basic structure of a thin film transistor and several energy band diagrams as viewed through the gate of an n-semiconductor, accumulation mode TFT [6]. The energy band diagram of Fig. 3.3b shows the device at equilibrium, with 0 V applied to the source, drain, and gate. Fig. 3.3c shows an energy band diagram with the gate negatively biased. The applied negative bias repels mobile electrons from the semiconductor, leaving a depletion region near the insulator-semiconductor interface. When compared to Fig. 3.3b, this biasing condition has a reduced conductance due to the reduced number of mobile electrons in the semiconductor. Figure 3.3d shows an energy band diagram with the gate positively biased.

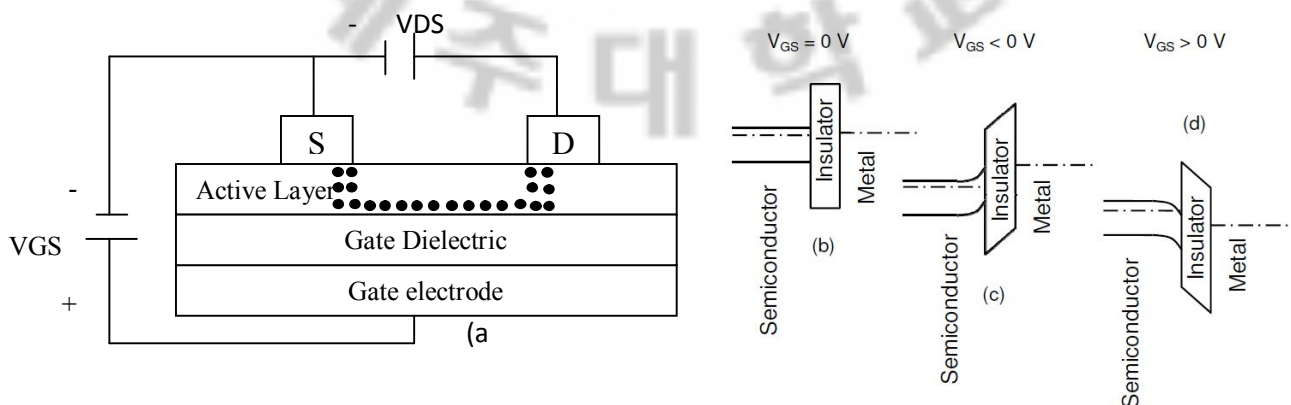

Fig. 3.3 (a) Basic structure of a TFT and corresponding energy band diagrams as viewed through the gate for several biasing conditions: (b) equilibrium, (c) $V_{GS} < 0V$, and (d) $V_{GS} > 0V$

The applied positive bias attracts mobile electrons, forming an accumulation region near the insulator-semiconductor interface. These excess mobile electrons lead to an increase in the conductance. Beginning with the case where the gate is biased positively and accumulation is established, i.e., Fig. 3.3d, consider the effect of an applied drain-source voltage, V_{DS} . Initially the semiconductor is modeled as a resistor, i.e. linearly increasing current with V_{DS} . As V_{DS} increases, accumulation near the drain decreases. As V_{DS} is increased further, the region near the drain eventually begins to deplete. The voltage at which the semiconductor region near the drain is fully depleted of carriers is denoted by the pinchoff voltage. Therefore, application of V_{DS} greater than the pinch-off voltage results in a saturated drain current characteristic [7].

3.3. Material Selection:

A variety of functional inks are required for inkjet printing, as the most prominent feature of these materials is the solution processability, inkjet printing is a wet media of transfer of structures onto a range of substrates. Each and every printing approach has its own intrinsic requirements like a specific range of viscosity, surface tension, solution conductivity, density and average particle size etc. Inorganic and organic nanoparticles based solutions with specific range of properties have been reported in literature. Accurate placement of ink using a mechanical printing process relies on two underlying physical properties; rheology and surface tension. The ability to vary these two key parameters depends upon the printing method used to apply them and the properties of the materials available to the formulator. Fig 3.4 is the generalization of one ink selection process for a desired application. Both the intended application and the desired printing process will govern the composition of the ink. The physical properties of the ink or wet, ink will be applicable to some, but not all applications. Thus identifying the function of the dry ink layer that is necessary to enable a desired application requires an understanding of the print process requirements and therefore the wet ink.

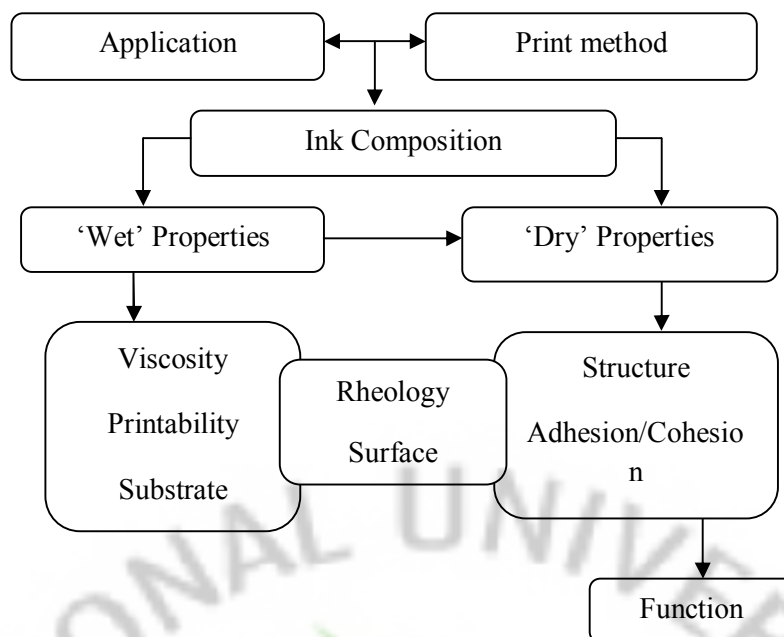

Fig. 3.4 Generalization of Ink selection

Rheology and surface energy are properties of both the wet and dry inks, and therefore greatly influence the printability of the ink. The factors determined by these properties are viscosity, substrate, dry ink structure, adhesion, cohesion and surface properties [5].

Inkjet inks are unique from other types of ink because they are not transferred by direct contact but are ejected from a nozzle contained within a print head onto a nearby substrate surface. Jetted inks are generally described as having a narrow viscosity range which allows these inks to flow through the print head and be propelled using the different printing actuation mechanisms. The sometimes-complex channels, through which the ink flows, and the relatively small nozzles or orifices of the print heads, impose limitations in the particle size that can be suspended within these inks. A ratio of 50:1 orifice to particle size is generally suggested to avoid clogging. The geometrical complexity of print head requires that the entire print head mechanism be made compatible with the ink solvent. Compatibility implies that no component of the ink will react with or change the properties of gaskets, seals, adhesives, or other components comprising the print unit. This is more important in inkjet than in other processes due to the construction of print heads and the difficulty in diagnosing a gradual decay in an internal component.

Most of the research on device physics and thin film electronics is reported by pursuing piezoelectric inkjet technology due to its versatility of application to a vast range of materials. All types of materials i.e. conductors; semiconductor and dielectrics can be ejected in the form of drop-on-demand onto a substrate. Mostly solution based organic (Polymer) materials are used for fabrication of thin film flexible electronics due to its low processing temperatures. Inherently conducting polymers (ICPs) such as polyaniline (PANI) and

polyethylene dioxythiophene (PEDOT) are recent alternatives. Unlike conductive pastes, they are compatible with high-speed printing methods. The low conductivity of ICPs, however, limits their use and attractiveness for printed electronics. Carbon nano-tubes (CNTs) are highly conductive and can be formulated into inks, but the cost and availability of CNTs are major drawbacks [13]. Nanotechnology has enabled this new generation of cost-effective, highly conductive inks that are compatible with high-speed printing methods. Several nano-sized silver-based inks are available for various printing methods. Silver (Ag) is the dominant metal used due to the relative ease with which Ag can be sintered. Typical curing temperatures range from 130°C to 150°C. Nano-copper inks are also in development as a low-cost alternative to Ag. Copper (Cu) oxidization makes sintering more difficult to accomplish. There are approaches to solving this problem, but so far, Ag is the best overall solution for printed electronics.

Nano particles are employed because of their remarkably lower melting temperature compared to bulk materials. This low melting temperature of nano particles is due to the large ratio of surface atoms to inner atoms. For example, a gold particle of 4 nm diameter has 25% of the atoms on the surface. This high portion of surface atoms drastically decreases the melting temperature, since smaller particles exhibit reduced interaction between the surface and the inner atoms; i.e., the surface energy of the surface atoms is reduced. To exemplify, the melting point for gold nano particles in the range of a few nanometers lies approximately between 300– 400 °C versus 1064 °C for bulk gold. The following graph in figure 2.5 shows the melting temperature depression with particle size reduction.

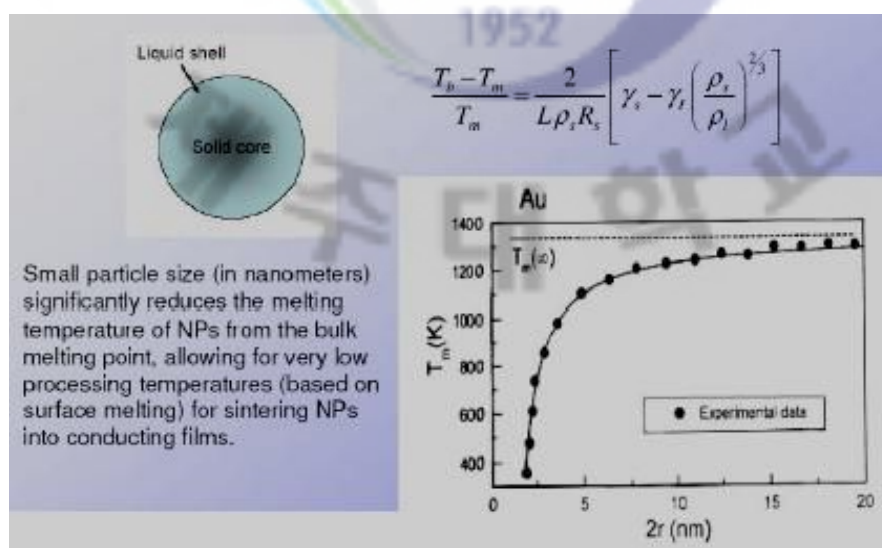

Fig. 3.5. Relation of Melting point against particle size

3.3.1. Colloidal Solution Used in our Research:

In our research we have used a variety of colloidal solutions containing Ag, ZnO and SiO₂ nanoparticles for the conductive contacts, semiconductor and dielectric layers respectively for direct fabrication of thin film transistors. Ag nanoparticles based colloidal is used frequently by most of solution processed and printing manufacturing technologies due to its stable properties in ambient environment. Also the compatibility of the sintering temperatures of Ag based inks with organic materials is another attractive feature and large bandgap as required by most of the holes dominant organic semiconductors.

Zinc oxide is one of the most widely used oxide semiconductors. In addition to its utilization as a transparent conductive oxide (TCO) material in microelectronics devices, zinc oxide is used in many health care products due to its absorption of the UV portion of the electromagnetic spectrum, light-emitting devices, as well as ceramic-based varistors. The optical band gap for zinc oxide is reported to be between 3.1 and 3.3 eV. Zinc oxide is typically polycrystalline, with a wurtzite structure and preferential grain growth in the c-axis direction (normal to the substrate), even on amorphous substrates. ZnO thin films have been deposited using a number of methods, including reactive sputtering (DC [14], RF [15], ion beam [16]), activated reactive evaporation (ARE) [17], spray pyrolysis [18], metalorganic chemical vapor deposition (MOCVD) [19], and electrochemical reaction [20]. More recently zinc oxide thin films have been fabricated from solution-based precursors [21]. In this thesis we have explored another efficient way to deposit solution based ZnO nano-particles using electrohydrodynamic spray deposition technology [22]. Zinc oxide is typically an n-type semiconductor, due to an inherent nature of forming an oxygen deficient film. However, recent reports have claimed that p-type doping of the material can be achieved. A high degree of n-type conductivity is attainable in zinc oxide, due to intrinsic defects, intentional donor doping (Al, In, Ga, B, F) or a combination thereof. Reported thin-film Hall electron mobilities are typically >20 to $30 \text{ cm}^2\text{V}^{-1}\text{s}^{-1}$; the maximum mobility obtainable in ZnO single crystals is $>200 \text{ cm}^2\text{V}^{-1}\text{s}^{-1}$. There is not a consensus in the literature as to which intrinsic defect (O vacancy or Zn interstitial) is responsible for intrinsic n-type conductivity. P-type conductivity has not been convincingly or reproducibly demonstrated, although compensation of n-type doping through the introduction of acceptor impurities is possible. This difficulty in obtaining p-type ZnO is attributed to the phenomenon of self-compensation.

Thin films of silica are quite beneficial in microelectronics where they act as electric insulators with high chemical stability. In electrical applications, it can enhance store charge, block current, and even act as a controlled pathway to limit current flow. In normal

procedures thin film of SiO₂ is grown on the surface of silicon wafer by using thermal oxidation processes. Solution processed SiO₂ has been very rarely reported in literature. We have tried to deposit solution based SiO₂ for dielectric layer of thin film transistors in this thesis. All the inks are provided by partner research groups.

3.4. Substrate selection:

Substrate selection (rigid or plastic) is mainly dependent on the sintering temperatures of the materials required for various layers of thin film electronics. As inkjet printing is an additive process and most of the device design is based on layer by layer manufacture, so a proper correlation of material physical properties and sintering temperatures are needed. Materials having sintering temperature more than 200°C limit the use of a wide range of flexible substrates. Surface roughness of substrates plays an important role in the adhesion of small particles. The strength of the adhesion of small particles on rough surfaces is mainly determined by the geometrical effects of the surface-particle system. The adhesion of particles smaller or similar in size than the dominant surface features is only weakly dependent on the particle size.

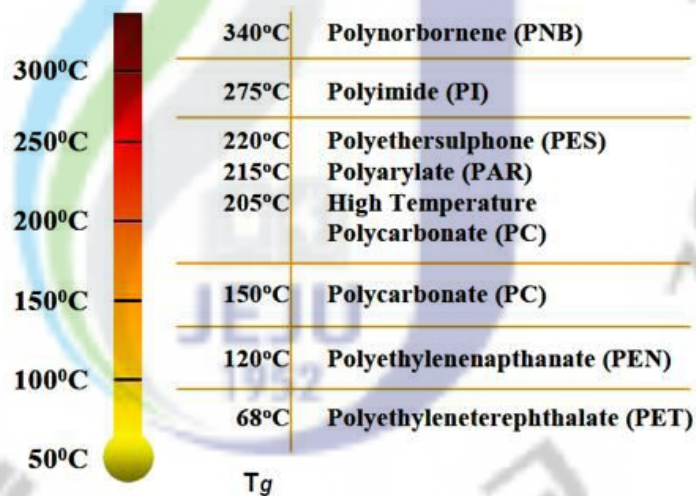

Fig. 3.6. Common flexible substrates and their sustainable temperatures

The interaction is limited to one contact between the particle and a single asperity and the strength of the adhesion is determined by this contact alone. Particles much larger than the surfaces features have several contacts with the surface leading to interaction where, in addition to the asperity geometry, the size of the particle has a major influence on the adhesion. Relative size of the adhering particle and the surface features play the most important role in the interaction.

References:

- [1]. Colin Reese, Mark Roberts, Mang-mang Ling, and Zhenan Bao, Organic thin Film transistors, *Materialstoday*, ISSN:1369 7021, Elsevier Ltd 2004
- [2]. Kateri E. Paul, William S. Wong, Steven Ready and Robert A. Street Additive Jet Printing of Polymer Thin-film Transistors,
- [3]. Kawase, T., Shimoda, T., Newsome, C., Sirringhaus, H. & Friend, R. H. Inkjet printing of polymer thin film transistors. *Thin Solid Films* **438**, 279-287 (2003)
- [4]. C. R. Kagan and P. Andry, *Thin-film transistors*. New York: Marcel Dekker, Inc.2003.
- [5]. Daniel R. Gamota, Paul Brazis, Krishna Kalyannasudran and Jie Zhang, Printed Organic and Molecular Electronics Kluwer Academic: 2004
- [6]. Tanase, C., Meijer, E. J., Blom, P. W. M. & De Leeuw, D. M. Local charge carrier mobility in disordered organic field-effect transistors. *Organic electronics* **4**, 33-37 (2003).
- [7]. David Hong, Fabrication and Characterization of Thin-film Transistor Materials and Devices, PhD Thesis, Organ State University, 2009.
- [8]. Oded Globermam, Lateral and Vertical Organic thin film transistors, Master Thesis, Technion-Israel Institute of technology, 2006
- [9]. G. Horowitz, R. Hajlaoui, H. Bouchriha, R. Bourguiga, and M. Hajlaoui, *Advanced Materials*, 10 (1998) 923.
- [10]. Po-Cheng Wang, Master Thesis, Study of the characteristics of Pentacene-OTFTs with PMMA as Dielectric layer, Industrial Technology R & D, 2007.
- [11]. D. K. Schroder, *Semiconductor Material and Device Characterization*. New York, John Wiley & Sons, Inc., 2 ed., 1998.
- [12]. A. C. Tickle, *Thin-film transistors*. New York: John Wiley and sons, 1969
- [13]. Jiantong Li, Ink-jet printing of thin film transistors based on carbon nanotubes, Doctoral Thesis, KTH, 2010
- [14]. L. J. Meng and M. P. dosSantos, "Direct current reactive magnetron sputtered zinc oxide thin films the effect of the sputtering pressure," *Thin Solid Films*, vol. 250, p. 26, 1994.
- [15]. T. Minami, H. Nanto, and S. Takata, "Highly conductive and transparent aluminum doped zinc oxide thin films prepared by rf magnetron sputtering," *Jpn. J. Appl. Phys.*, vol. 23, p. L280, 1984

- [16]. A. Valentini, F. Quaranta, and M. Penza, "The stability of zinc oxide electrodes fabricated by dual ion beam sputtering," *J. Appl. Phys.*, vol. 73, pp. 1143–1145, 1993
- [17]. W. S. Lau and S. J. Fonash, "Highly transparent and conducting zinc oxide films deposited by activated reactive evaporation," *J. Electron. Mater.*, vol. 16, pp. 141–149, 1987.
- [18]. J. D. Merchant and M. Cocivera, "Preparation and doping of zinc oxide using spray pyrolysis," *Chem. Mater.*, vol. 7, pp. 1742–1749, 1995.
- [19]. W. W. Wenas, A. Yamada, K. Takahashi, M. Yoshino, and M. Konagai, "Electrical and optical properties of boron-doped zinc oxide thin films for solar cells grown by metalorganic chemical vapor deposition," *J. Appl. Phys.*, vol. 70, pp. 7119, 1991
- [20]. M. Izaki and T. Omi, "Transparent zinc oxide films prepared by electrochemical reaction," *Appl. Phys. Lett.*, vol. 68, pp. 2439–2440, 1996.
- [21]. B. Norris, J. Anderson, J. Wager, and D. Keszler, "Spin-coated zinc oxide transparent transistors," vol. 36, pp. L105–7, 2003
- [22]. Kyung Hyun Choi, Saleem Khan, Dang Hyun Woo, Yang Hoi Doh, and Sung Jei Hong, Electrohydrodynamic Spray Deposition of ZnO Nanoparticles, *Japanese Journal of Applied Physics* 49 (2010) 05EC08, DOI: 10.1143/JJAP.49.05EC08

Chapter # 4

Development of Electrostatic Inkjet Head by Integrating Metallic and Silica Capillaries for Stable Meniscus

This chapter discusses about the stability and analysis of meniscus and results on substrates using a newly developed inkjet head for electrohydrodynamic printing system. Conventionally an electrode is inserted vertically into the fluid for generating electric field to induce charges that move towards the surface of the liquid. Disturbances and vibrations in the inkjet head, caused by the application of high electric potential to vertically inserted thin electrode, is the main problem affecting the stability of the meniscus. Centralization, obstruction to the fluid flow and the fixed position of vertically inserted electrode in the inkjet head adds to the complexity of the system design. In order to overcome all these limitations, a new technique has been developed and verified experimentally. A Metallic capillary enclosed by tapered glass capillary results in removing obstructions to the fluid flow caused by inserting electrodes from top into the capillary head. The voltage applied in new setup for extraction is reduced, verified by simulation and followed by testing through experiments in the lab. Electrode within the fluid channel remains at fixed point eliminating the positioning problems that occur with vertically inserted electrodes for repeatable parameters. Also the electric field along the periphery of the meniscus can be more concentrated with reducing the nozzle orifice diameter in metallic enclosed glass capillary head. With this head design, uniformity of the patterned lines is enhanced by obtaining a stable meniscus. Resolution of the printed patterns on flexible polyimide substrate is minimized. Solution used in this experimental investigation having properties of 39.68 weight percentage of Ag nano particles, viscosity of 39 cps and 5 dyn/cm of surface tension is used.

4.1. Introduction and motivation for development of an inkjet head:

Printing technologies have evolved in revolutionizing the electronics industry. Thin film and flexible electronics through printing is the focal research topic of many academic and industrial research groups now-a-days. Printing is the most easy, environment friendly and cost effective technology. Pattern lines can be printed directly in one step instead of many steps involved in conventional photolithography technique. High temperature processing steps involved in photolithography are the main bottlenecks for flexible electronics fabrication. Different printing techniques have been developed and employed depending on the resolution of the print lines and devices. Among all these techniques, Inkjet printing technique is very simple and attractive for forming micro-size patterns for flat panel displays (FPDS), printing circuit board (PCB), semiconductor, biological, optical, and sensor devices due to its low temperature process, direct writing, and rapid prototyping process [1-3]. Some of the performance parameters such as high frequency jetting, high aspect ratio, low pattern resolution, size of droplet and uniformity of droplet size are required to fulfill the requirements of various applications [4].

The most focused research area among direct patterning techniques is the electrohydrodynamic printing (EHDP). Jetting devices based on thermal and piezoelectric are commercialized; however they have some fundamental limitations to overcome in order to meet the requirements for the future generation of jetting devices. Thermal bubble actuator has the heat problem when used in an array of nozzle in thermal inkjet printing system. In piezoelectric actuator it is difficult to make droplet smaller than nozzle size. Also, the head consisting of piezoelectric or a heater element has the disadvantage of the complex structure [5]. Electrostatic inkjet printing has a greater advantage than the piezo inkjet and thermal inkjet in the ability to eject fine droplets and in simplicity of structure.

In electrohydrodynamic inkjet nozzles, electrode position at a fixed point in vertically inserted electrode (VIE) head setup is one of the big issues, which is very difficult to maintain for repeatability of experiment. Also the disturbances and vibrations caused by the micron sized tip due to the application of very high electric potential add to the unstable meniscus which results in nonuniformity and irregular boundaries of the pattern lines drawn on the substrate. Centralization of the electrode in the ink channel adds to the complexity of the inkjet head design. Ink bank charging, back flow of the fluid and agglomeration of nanoparticles are also the main issues with VIE configuration. This section presents a simple

method of maintaining the electrode position in the fluid channel for getting repeatable experimental parameters using a metallic capillary enclosed in a glass (MEG) nozzle. The metallic capillary serves as a fluid channel and electrode as well. Low applied voltage is required for uniform jetting in the new configuration. The obstructions to fluid flow are avoided and patterns with minimum width are able to achieve.

4.2. Nozzle Head Designs:

Two types of nozzle designs are developed and used for checking meniscus stability. First the conventionally used vertically inserted electrode (VIE) inkjet head is designed in lab. The second nozzle design i.e. metallic enclosed glass (MEG) nozzle is also fabricated and developed in the lab. The two configurations and designs are discussed in full detail in the following sections.

4.2.1 Vertically inserted electrode head design:

In general practices a metallic electrode is inserted from top into the capillary tube for charge induction to the ink in a tapered glass capillary. For development of VIE inkjet head a nozzle made of poly di-methyl siloxane (PDMS) has been used. Micromachining fabrication steps and materials used are listed as, first Sylgard 184 Silicon Elastomer base Sylgard 184 silicon elastomer curing agents are mixed in a ratio of 10:1 and then mixed on shaker at 70-90 rpm for 20 minutes or until bubbles are removed from the mixture. Then it is poured into the dye by making sure that no bubble is generated inside the head nozzle dye. This stage is repeated until the bubble-less dye is filled. Then it is cured by putting in furnace at 80 °C for 1 hour. After removing from the curing furnace, the die assembly is dismantled followed by connecting ink delivery channel and power supply connections; the head is tested for blockage. After getting the clearance from the blockage and connecting with power supply, the head is ready to be used on the system. The fabricated nozzle head consists 1.5mm channel in which glass nozzle is fixed with 60 μm orifice and 20 μm electrodes is used. Schematic of the model is shown in fig below.

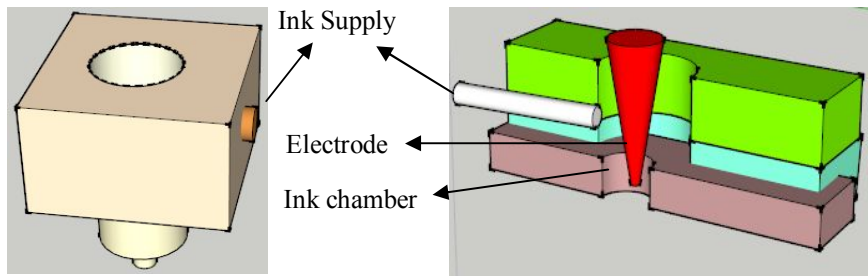

Fig 4.1. VIE Nozzle made from PDMS

4.2.2 MEG nozzle head configuration

The most intrinsic problems with the VIE setup are the electrode positioning and vibrations produced as a result of high electric potentials. Inserting electrode from top into the ink channel, it is difficult to maintain the same position of electrode when repeating the experiment. To overcome these problems a new head design is presented in this paper. A metallic capillary is enclosed by a glass capillary. Metallic capillary is enclosed up to the starting point of the tapered part of the glass capillary. In this way the distance between the metallic capillary and glass capillary orifice can be maintained fixed all the time. Glass capillary with reduced nozzle orifice is used because as the nozzle diameter decreases, the electric field along the periphery of the meniscus can be made more concentrated [5]. In this study a full package of holder, nozzle head, holder for glass capillary and counter electrode have been developed as shown in Fig 4.2. All the processing steps have been performed by micro machining starting from top of the holder up to the metallic capillary's adapter part.

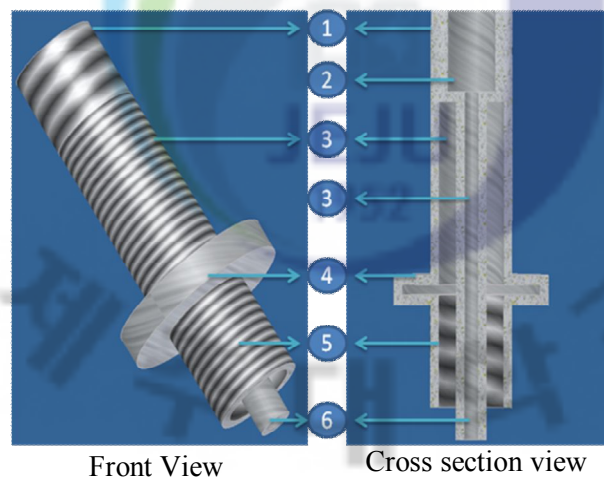

Fig. 4.2. Upper part of the nozzle with holder

A channel of fluid is connected to the adapter of the upper threaded part (1) of the holder from the main reservoir. A temporary reservoir (2) is used for continuous delivery of the fluid. The outer threaded part (3) of the holder is used to mount and fix the holder at preferred place in the setup. Metallic capillary is connected to the adapter (6) from bottom for the nozzle head configuration. Metallic capillary is then enclosed by a tapered glass capillary.

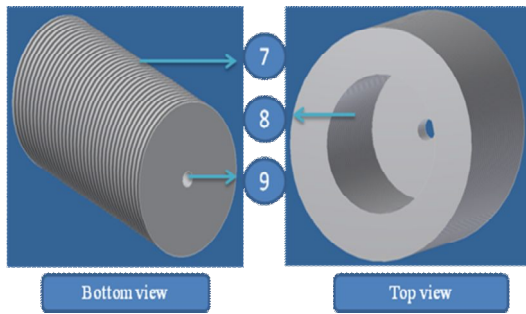

Fig. 4.3. Lower part of the nozzle

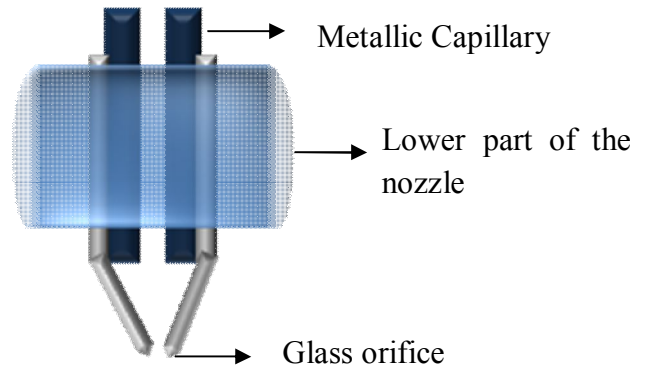

Fig 4.4 MEG nozzle configuration

Glass capillary is fixed into the lower part (7) in Fig. 4.3 of the nozzle head by using a holding element in the inner lower part, in order to hold the glass capillary firmly. The lower part is then mounted onto the upper part through the outer threaded part (5). The outer side of the lower part (7) in Fig 4.3 is also made threaded in order to make space for counter electrode. The internal diameter of the glass capillary must be greater a few order of micrometers from the outer diameter of the metallic capillary as shown in Fig 4.4 above, so that metallic capillary can easily be inserted. Metallic capillary should be inserted to the end of glass capillary and start of tapered point. The setup can be used in either case i.e. for discrete type by following pin-to-pin, pin-to-plate or pin-to-line configurations. Fig 4.5 shows the dimensional analysis of the upper and lower parts of the inkjet nozzle head.

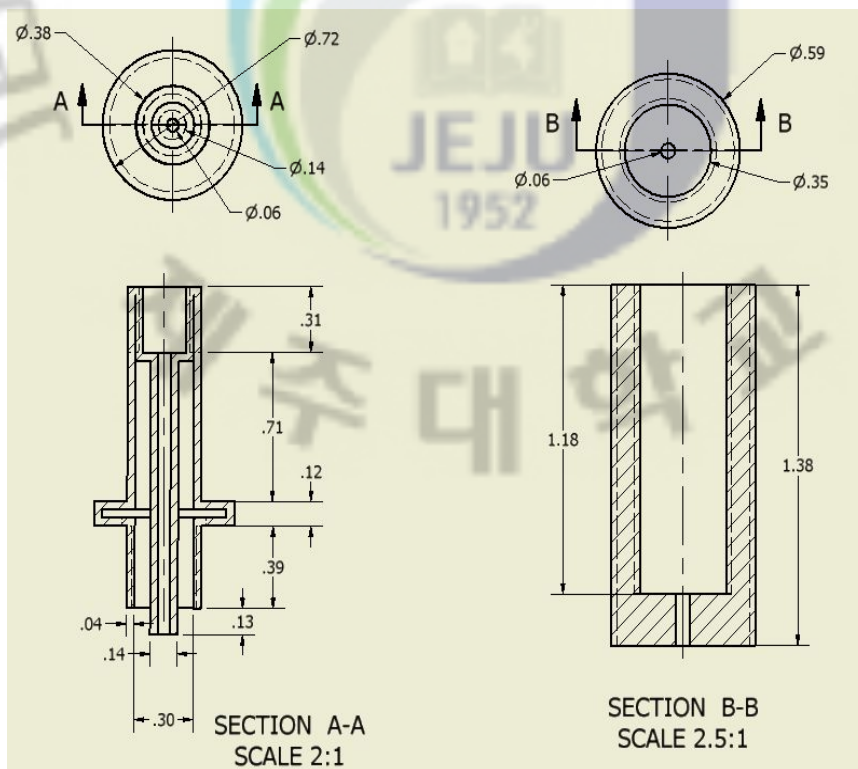

Fig. 4.5. Dimensions of the upper and lower parts of the nozzle

4.3. Electric field simulation

Simulation is done with commercially available software (Comsol MultiPhysics 3.5A) to check the electric field lines and strength at the electrode tips using both configurations. Intensity of electric field lines at the orifice of glass capillary using vertically inserted electrode is observed to be less than that obtained using metallic enclosed glass capillary as shown in Fig 4.6 and Fig 4.7 below.

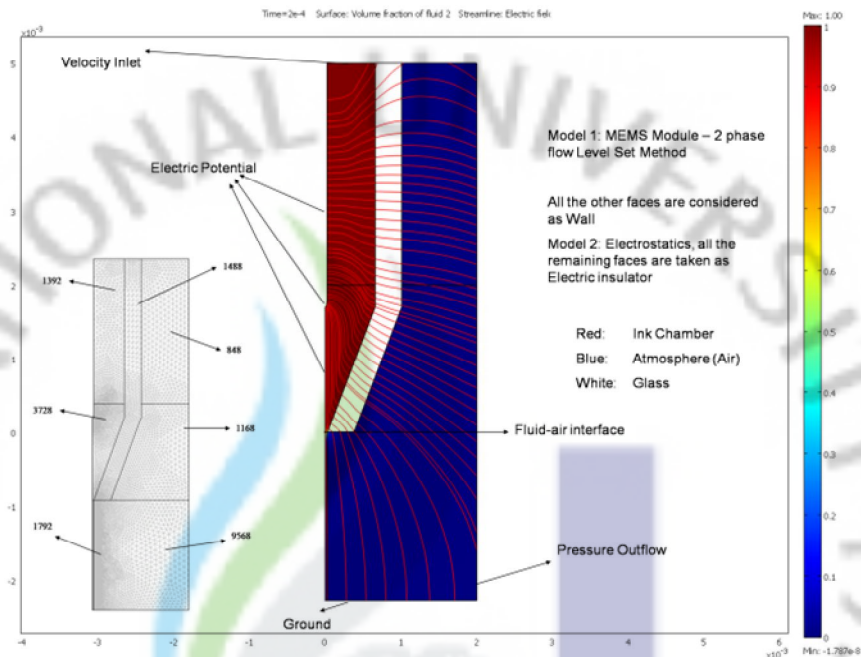

Fig. 4.6 Electric field lines simulation of VIE

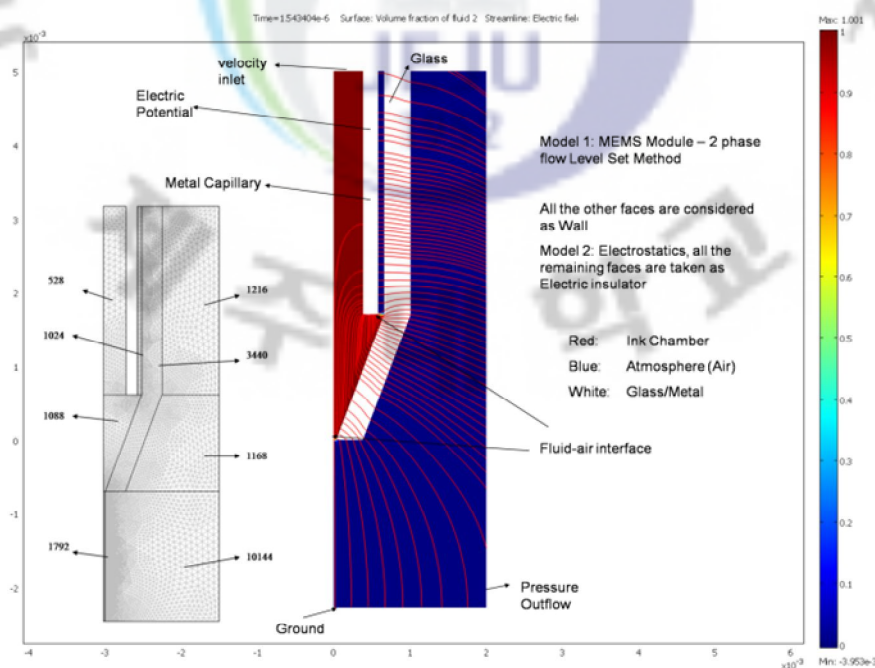

Fig. 4.7 Electric field lines simulation of MEG

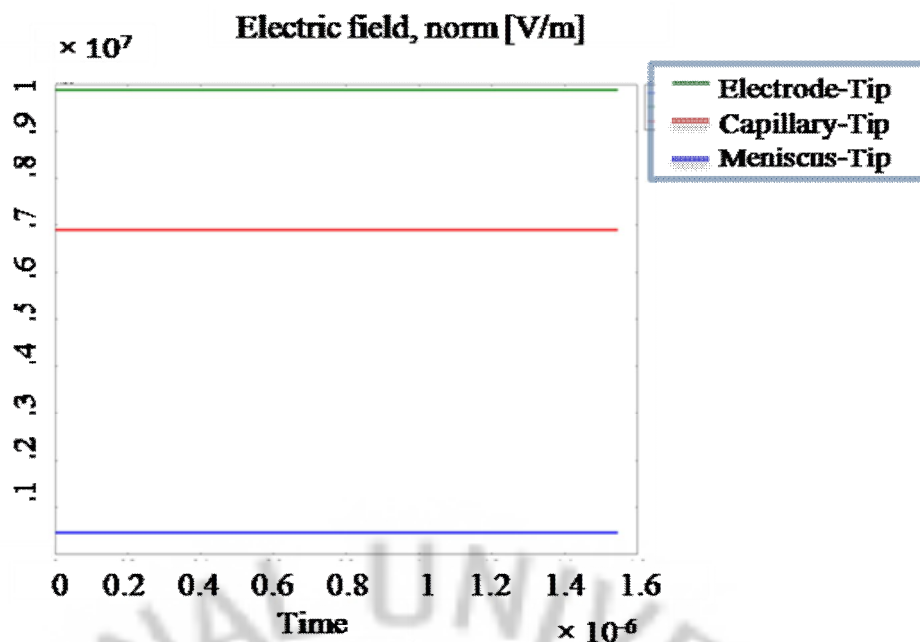

Fig. 4.8. Simulation of field strength at three points using VIE

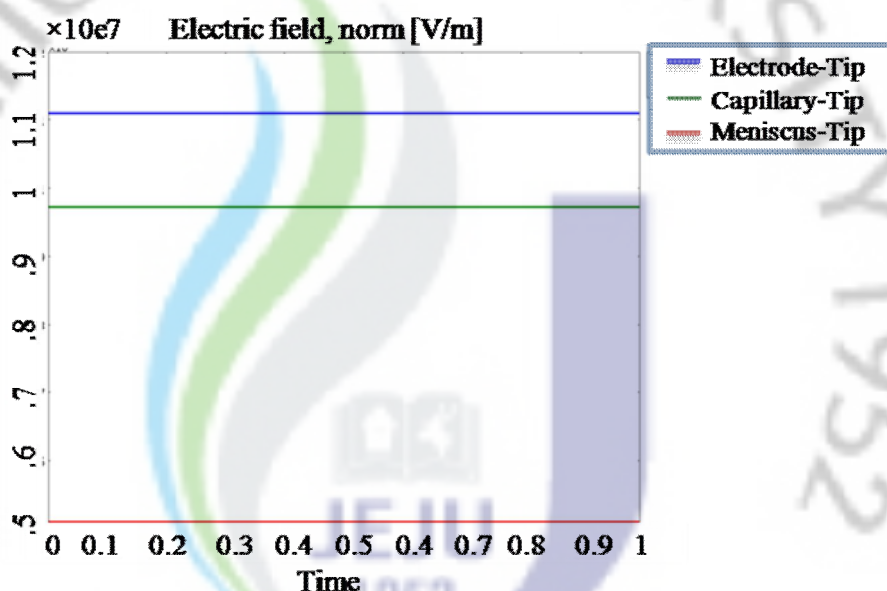

Fig. 4.9 Simulation of field strength at three points using MEG

The electric field strength required for ejection of the fluid is observed to be higher for vertically inserted electrode as compared to metallic enclosed glass capillary configuration. The simulation results obtained at single reference points are given in Fig 4.8 and Fig 4.9.

4.4. Experimental analysis and comparative study

For investigating the behavior of ink through electrohydrodynamic inkjet deposition technique, lab developed system was used. Fig 4.10 and 4.11 show the schematic of the EHDP system and lab developed system respectively. The equipment used in deposition system consist of a vertically inserted electrode into capillary head, metallic capillary enclosed by tapered glass capillary, high voltage power supply, syringe pump or ink supply,

X-Y stage motor control, substrate holder, high speed camera and nozzle holder with Z-axis control. Metallic capillary with inner diameter of $430\mu\text{m}$ and outer diameter of $630\mu\text{m}$ was enclosed by glass capillary with internal diameter of $.78\text{mm}$ and outer diameter of 1.5mm with $60\mu\text{m}$ tapered orifice.

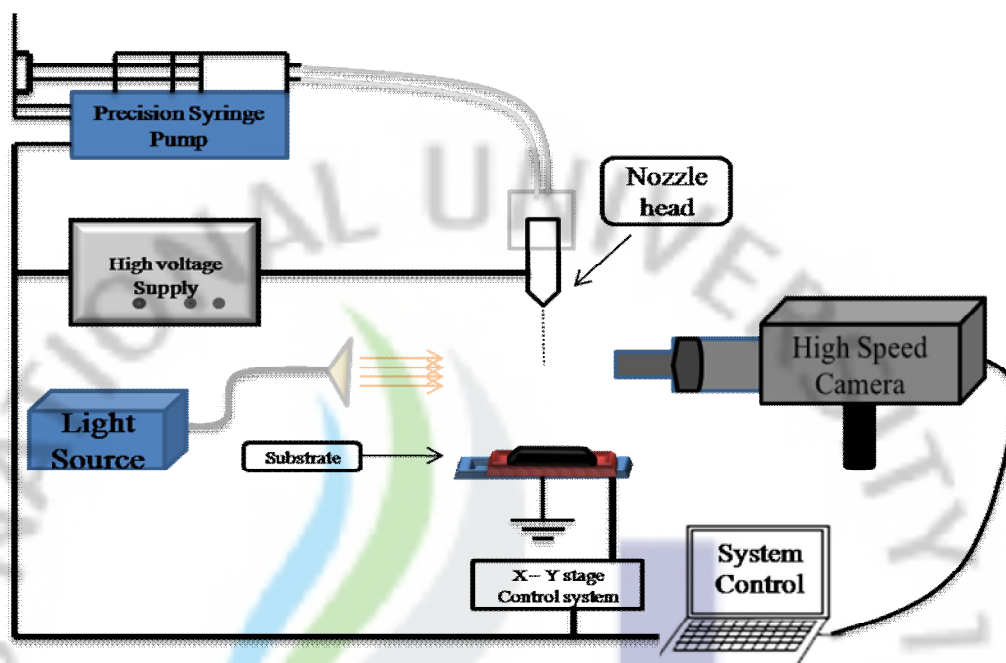

Fig. 4.10 Schematic diagram of electrohydrodynamic inkjet system

In this setup the electric field produced, was obtained by the application of high electric potential between the two electrodes. Positive potential is applied to the nozzle head while ground is applied to the conductive plate kept at a distance of 3.7mm below the nozzle tip. Distance was adjusted by observing and analyzing various dripping modes, meniscus stability and behavior of the jetted particles. The liquid pressure was controlled by pressure injection pump, flow rate kept at $15\mu\text{l/hr}$. To maintain the uniform static pressure in the ink chamber, the inlet flow rate is very important because of ejection of the ink during the jetting process. High speed camera of Motion pro X4 with $11\times$ zooming magnification of the lens is used for observing the phenomenon. Voltage was kept increasing until a stable meniscus was formed.

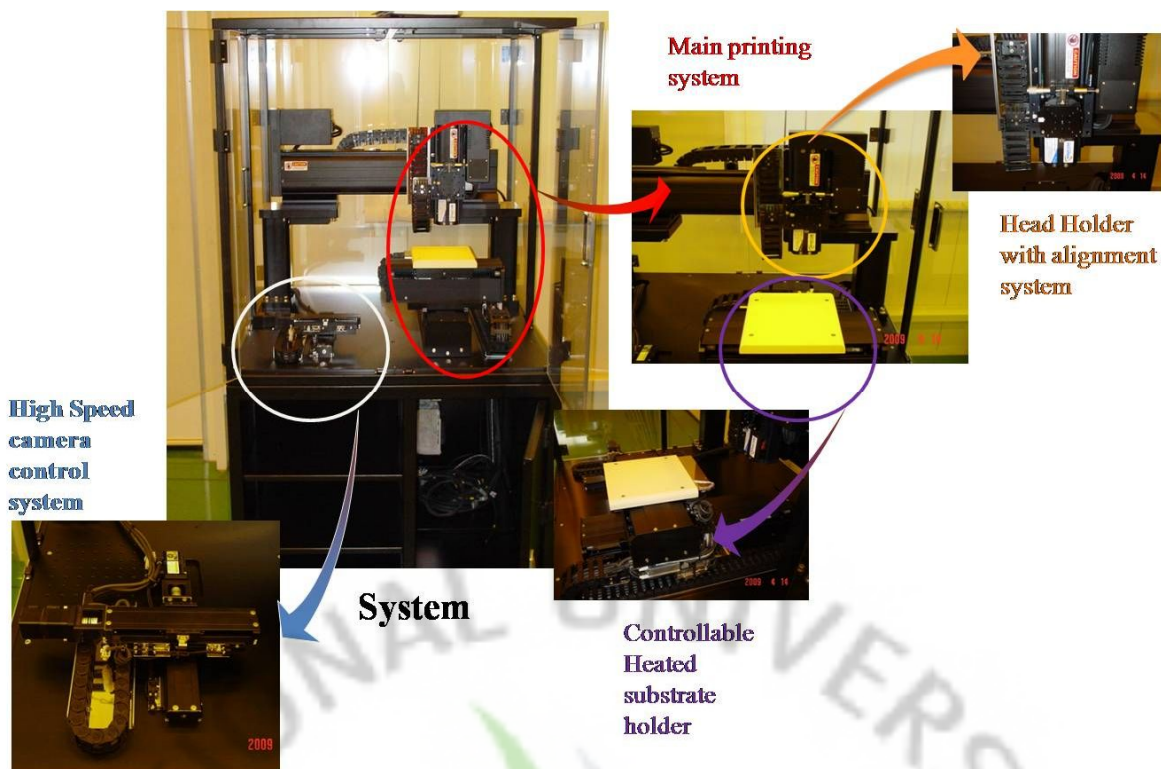

Fig. 4.11 Lab developed inkjet

Table. 4.1. Experimental Parameters.

Electrode Configuration in inkjet head	Tip to substrate distance (mm)	Applied potential for getting meniscus, (kV)	Flow rate $\mu\text{l/hr}$	Nozzle diameter μm
Vertically Inserted single electrode (VISE)	3.7	7.4	10	80
Metallic enclosed glass capillary (MEG)	3.7	6.2	10	80

4.5. Results and discussion

In both experimental setups same fluid with the same properties was used for polyimide and glass substrates. All experimental parameters were kept constant except changing the nozzle head configurations. It is observed that the voltage required for extraction of fluid in case of vertically inserted electrode is more than the metallic enclosed glass capillary. The optimum voltage experimentally obtained for stable meniscus of vertically inserted electrode is 7.4kV when polyimide substrate is used. Optimum voltage for stable meniscus of metallic enclosed glass capillary is 6.2kV using polyimide substrate. Fixed and firm position of the electrode capillary plays important role in the uniform distribution of charges to the fluid. The vacuum of charges generated by ejection of droplets from the surface is filled abruptly without any delay in MEG capillary. Since the liquid is contained in a metallic capillary, the electric field within the nozzle is zero. Therefore there is no charge separation in the nozzle and electrical neutrality of the liquid is maintained. The electrochemical reaction occurring at

metallic capillary end and formation of the electric double layer results in increased charge density in MEG head [6].

A very stable meniscus obtained with using MEG capillary head is shown in Fig 3.12. Different dripping modes and jetting modes observed with high speed camera.

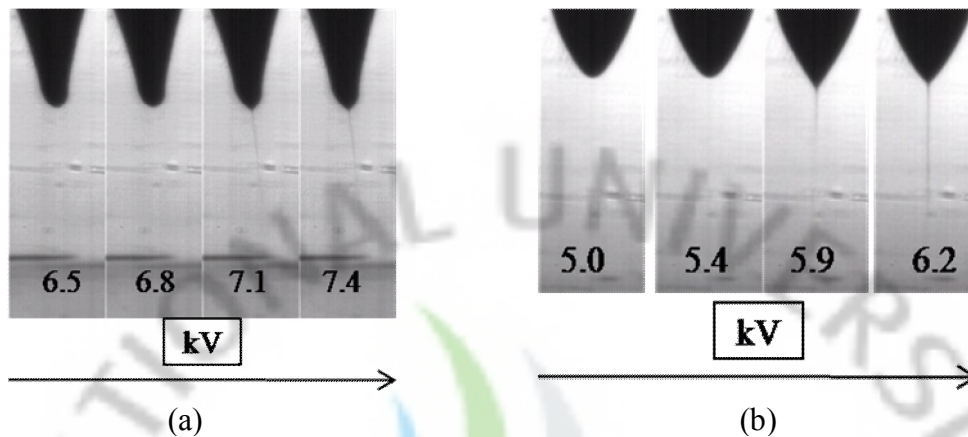

Fig. 4.12 a) Unstable meniscus and jetting by using VIE with polyimide substrate b) Stable meniscus and jetting by using MEG capillary with polyimide substrate

Fig 4.13 shows the trend of resolution of the patterned lines obtained by using MEG capillary and VIE capillary heads. In these results the electric field range forming cone jet is in the range of 1.0–1.6kV / mm by using metallic enclosed glass capillary head, while 1.45-1.95 kV / mm was the electric field range by using VIE capillary head depending on the substrates used.

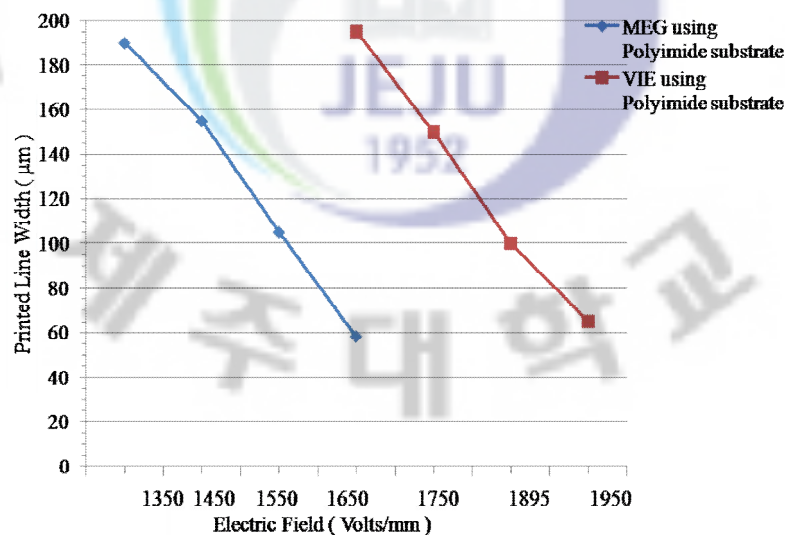

Fig. 4.13 Trend of printed lines on polyimide substrate

The pattern lines obtained with metallic enclosed glass capillary are more uniform. No blockage and particle agglomeration occurred in MEG capillary head by using it several times for experiments. Fig. 4.14 (a & b) show the results obtained with vertically inserted

electrode from top into the capillary and MEG capillary respectively. The printed line's width ranges from 40 μ m to 150 μ m, the problem occurs from the moving stage. The speed of the moving stage does not match with the jet speed, as a result it makes the accumulation phenomenon of the nanocolloid solution. Spreading phenomenon of the fluid on substrates also adds to increased width of the printed patterns.

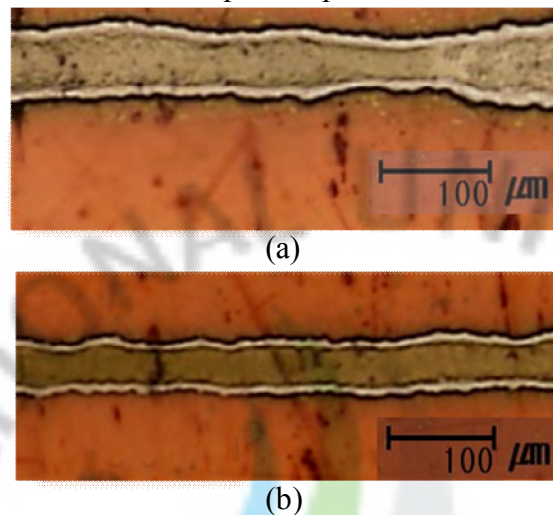

Fig. 4.14 a) Patterning on polyimide substrate with vertically inserted electrode capillary head, b) Patterning on polyimide with metallic enclosed glass capillary head

4.6. Conclusions

The above simulation and experimental investigation of both inkjet heads configurations show that a very stable meniscus can be formed by using metallic enclosed glass capillary which results in enhancing the uniformity of the printed patterns on flexible substrates. The main reason for this is the minimized vibration caused by electrode with micron sized tip within the fluid which is affecting the meniscus stability. In MEG head configuration, resistance to the flow of fluid is omitted. The hollow conductor in the form of metallic capillary is used for smooth flow of fluid. As more area of the conductor is exposed to the fluid and the reduced distance between metallic capillary and orifice of the glass nozzle help in induction of electrical charges more quickly. Speed of inkjet head is increased by increasing the number of nozzles and the new MEG inkjet head is very suitable for multinozzles configuration. Preliminary experiments are also performed on multinozzles configuration. Effects of electrode's position in the ink chamber can be maintained fixed with MEG print head for repeatability of the process. Vibrations and whipping behavior of the meniscus at the tip are minimized. From this experimental study we conclude that for high resolution and uniform printing, a stable meniscus plays very important role and a metallic enclosed glass capillary inkjet head can be used to enhance the stability of meniscus. In future

the proposed model will be miniaturized and developed for multinozzles configuration through MEMS technology in order to enhance the speed of electrohydrodynamic printing system.

REFERNCES

- [1]. E. Lee, *Microdrop Generation*, CRC Press, 2003.
- [2]. S. Lee, D. Byun, S. J. Han, S. U. Son, Y. J. Kim, H. S. Ko, “Electrostatic Droplet Formation and Ejection of Colloid,” *MHS*, July 31, 2004.
- [3]. C.M. Ho, *Fluidics-the link between micro and nano sciences and technologies*, Proc. IEEE Int. Conf. MEMS, 2001, pp. 375–384.
- [4]. Sukhan Lee, Doyoung Byun, Daewon Jung, Jaeyong Choi, Yongjae Kim, Ji Hye Yang, Sang Uk Son, Si Bui Quang Tran, Han Seo Ko, Elsevier, 2008, p. 506-514
- [5]. Youngmin Kim, Sanguk Son, Jaeyong Choi, Doyoung Byun, and Sukhan Lee: *Journal of Semiconductor Technology and science*, Vol. 8, No.2, June, 2008
- [6]. Hak Fei Poon, “Electrohydrodynamic Printing” PhD thesis, Princeton University 2002

Chapter # 5

Direct Patterning and Electrospray Deposition through EHD for fabrication of Printed Thin Film Transistors

This section presents fabrication of thin film transistors using direct write technology following electrohydrodynamic approach for patterning and spray deposition. In this research colloidal solution of Ag nanoparticles is used for patterning of gate, source and drain contacts, while SiO₂ & ZnO colloidal solutions are used for dielectric and semiconductor layers of TFTs using EHD printing technology. For direct patterning, different electrode configurations for inkjet head are used and a new nozzle head is developed for getting stable meniscus and uniform patterning. To minimize the disturbances caused by vertically inserted thin electrode, a hollow conductor is used in new setup, which serves both for ink feed and as an actuation electrode. The new configuration helps in minimizing the extraction voltage for jetting and also repeatability of experiment by keeping fixed parameters of the nozzle head is possible. By using metallic enclosed glass capillary head, conductive pattern lines for gate, source and drain contacts with good uniformity and regular boundaries are printed on glass substrate. Conductive lines having width of around 70 μm are achieved with appreciable aspect ratio. A channel length of 50 μm and width of 1.5 mm is obtained by using EHD direct printing of Ag colloidal solution. Layer thickness of SiO₂ achieved is around 300nm while ZnO thickness achieved is around 100nm. A standard deviation in layer thickness of around 25 nm for SiO₂ and 10 nm for ZnO electrosprayed layers is observed. A complete prototype of thin film transistor has been successfully fabricated by using EHD technology in this research. Contact angle analyzer is also used for finding various parameters like contact angle, wetting energy and spreading coefficient of the colloidal solutions which helps in determining the surface properties of the deposited layers.

5.1. Overview of Available Fabrication Technologies:

Thin film transistors (TFTs) and flexible electronics through printing is the focal research topic of many research groups now-a-days. Pattern lines can be printed directly in one step instead of many steps involved in conventional photolithography technique. The high-resolution electrohydrodynamic printing (EHDP) and electrospray deposition (ESD) techniques are of particular interest as an alternative to conventional vacuum deposition and photolithographic patterning of various functional films such as gate electrodes, gate dielectrics, source and drain contacts and active semiconductor layers. High temperature processing steps involved in photolithography are the main bottlenecks for flexible electronics fabrication whereas direct printing is the most feasible technique for solution processed materials at room temperature. Different printing and deposition techniques have been developed and employed depending on the resolution of the print lines and layer thickness of the devices. Among all these techniques, Ink-jet printing is very simple, versatile and attractive for forming micro-size patterns for flat panel displays (FPDS), printing circuit board (PCB), semiconductor, biological, optical, and sensor devices due to its low temperature process, direct writing, and rapid prototyping process [1-3].

Several methods are applied to deposit the semiconductor and dielectric layers of TFTs using physical and chemical vapor deposition technologies, sputtering, pulsed laser deposition, chemical vapor deposition, molecular beam epitaxy, in addition to spin coating, and sol-gel processes [4-9]. The flexible polymer substrates are chemically incompatible with resists, etchants and developers used in conventional integrated circuit processing. Conventional deposition and coating techniques require a controlled environment of pressure and temperature. Direct deposition of dielectric and semiconductive layers in thin film transistors (TFT) through electrospray is of meticulous attention as a substitute for conventional deposition practices. Compared to other deposition techniques, electrospray deposition (ESD) bears the advantage of high deposition efficiency (up to 80%) and reduction of the process steps as the droplets are transported by electrical forces [10]. Quality of the deposited film depends on the interaction between the design (nozzle-substrate distance and nozzle diameter) and spraying parameters (liquid feed rate, electrical potential) as well as material properties (solution viscosity, conductivity, absorption and density). Recent advancements in electrospray technologies have been briefly reviewed by Salata [11] and Jaworek [12]. Size of the disintegrated spray particles

range from hundred micrometers down to several tens of nano meters. Efficiency of the charged particles to be deposited on a surface is higher in comparison to uncharged particles [13].

Most organic semiconductors based printed transistors have low mobility which is adequate for some displays. For this reason solution-processable inorganic materials that are stable in air and suitable for solution processes have drawn research interest. Zinc oxide (ZnO) is a semiconductor with wide band gap ($E_g = 3.37\text{eV}$), making it an excellent candidate for fabricating transparent transistors, UV light-emitting diode (LED) lasers, piezoelectric, gas sensors, chemical sensors, and many other applications. It is inexpensive, relatively abundant, chemically stable, easy to prepare and non-toxic as compared to other competitors. Being an oxide, effects of environmental conditions on ZnO are minimum. Most printable semiconductors today are p-type and available n-type semiconductors have mobility $<10^{-2}\text{ cm}^2\text{ V}^{-1}\text{ s}^{-1}$, which is generally considered to be too low for most printed electronic applications. Additionally many printable semiconductors, including organics and chalcogenides are toxic, and their integration into disposable circuits is problematic. Also for display applications, none of these materials is transparent. Electro spray of SiO_2 has been reported by a few research groups but only some of them have cited the achieved thickness on a glass substrate for device fabrication [14-18]. Ghimbeu et al. reported electro spray of ZnO by achieving 7 μm thick layer for gas sensors [19]. Jaworek et al. reported electro spray of ZnO using very high voltage (i.e.25 kV), while achieving very irregular and thick layer on polyimide substrate [20]. In this paper deposition of ZnO has been reported with low voltage (7.8 kV, almost 3 times less) with good uniformity and surface roughness values.

5.2. Comparison of Analytical and Experimental Values of Onset Voltages for Electrohydrodynamic Phenomena:

In electrohydrodynamic inkjet printing system the fluid is electrified and ejected through the nozzle with the help of electrical forces by applying high voltage [21]. Electric charges are effective at the surface of the liquid meniscus, and an electric stress stretches the meniscus. At a certain value of applied voltage the meniscus of the liquid is deformed into a sharp cone and charged liquid droplets are ejected from the nozzle [22]. The effective forces acting at the

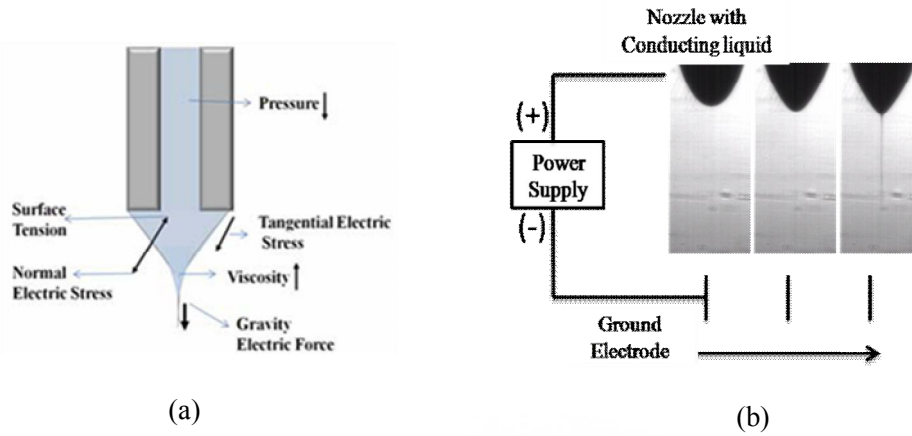

Fig.5.1 (a) Schematic of meniscus and affecting forces. b) Meniscus shape after application of electric potential.

meniscus consist of gravitational force, surface tension, viscous, electric and the flow rate pressure as shown in the Fig. 5.1. As soon as the electric forces accompanied by flow pressure exceed the surface tension forces, ejection of droplets begin. For ejection of the micro-droplet, the liquid meniscus is affected mainly by two forces: an electric field force and the surface tension force [23]. Various models have been presented in literature and relationships are found for calculating theoretically the optimum parameters. Based on the configuration of the electrohydrodynamic inkjet system, Loeb et al. developed an equation for electric field at the tip of the capillary [24]:

$$E_c = \frac{2V_c}{e \ln\left(\frac{4d}{r}\right)} \quad (5.1)$$

Here E_c is the electric field at the capillary, V_c is potential at the capillary, r is the capillary outer radius, and d is the distance between capillary tip and counter electrode.

To solve the electrical potentials required, useful equation derived by Smith [25], can be used:

$$E_0 = \sqrt{\frac{2\gamma \cos \theta}{\epsilon_0 r}} \quad (5.2)$$

Here E_0 is the onset electric field, γ the surface tension of the liquid, θ is angle of the Taylor cone, ϵ_0 is the permittivity of vacuum and r is the radius of the capillary. By combining equation of the onset electric field with that of the capillary electric field by configuration, the required onset potential at which the cone jet starts can be estimated as

$$V_0 = \sqrt{\frac{r\gamma \cos \theta}{2\epsilon_0}} \ln\left(\frac{4d}{r}\right) \quad (5.3)$$

$$V_0 = 2 \times 10^5 \sqrt{r\gamma} \ln \left(\frac{4d}{r} \right) \quad (5.4)$$

Permittivity of free space is $J^{-1} C^2 m^{-1}$ while θ is taken the Taylor angle i.e. 49.3° [26]. The above mentioned equation can be used to find the approximate value of onset electric potential.

It has been observed that the values obtained for the onset voltage experimentally is greater than that calculated analytically by using equation 4. Onset voltage in patterning experiment is observed to be around 4.2 kV while calculated value by using the known parameters in equation 4 is around 3.9 kV. Similarly the experimental onset voltages observed for SiO_2 and ZnO are 4.3 and 5.1 kV respectively, while the calculated values for both of these solutions are 3 and 2.5 kV. Variation in both the cases is expected as other experimental parameters are involved in this phenomenon. In theoretical calculations we make calculations according to the internal diameter of the capillary nozzle, while the case is different during experiments. Due to wetting of the fluid around the capillary tip, the base of the cone is emerged from the outside of the capillary nozzle and it takes more onset voltage experimentally than analytically calculated value. Second reason for more onset voltage value is considering the solution as homogeneous while a colloidal solution is used for experiments. Besides dependence upon surface tension, radius of capillary and distance between the electrodes some other experimental parameters like flow rate and dielectric strength of the solution also play important role in the onset voltage. In usual practices operating envelope is developed between the onset, optimum, and unstable region of the developed jet.

5.3. Colloidal Solutions Used

For the complete structure of thin film transistor three different types of colloidal solutions were used. For the gate, source and drain contacts Ag nanoparticles based ink was used provided by NPK Co. Ltd. South Korea. NPK-02 having resistivity of $1.051 \times 10^5 \Omega \cdot cm$, particle weight percent of 39.68%, viscosity of 39 cps and surface tension of 5 mN / m was used. For dielectric and semiconductor layers of the transistor, colloidal solution of SiO_2 and ZnO provided by KETI (Korea Electronics Technology Institute) was used. Average particle size of both the inks is around 15 nm. Surface tension of SiO_2 is 30.31 mN / m, while for ZnO the surface tension value is 28.97 mN / m.

5.4. Inkjet Nozzle head development

Conventionally a metallic electrode is inserted from top into the capillary tube for charge induction to the ink in a tapered glass capillary. Most intrinsic obstacles for stable inkjet nozzle head are the electrode positioning and vibrations fashioned as a result of high electric potentials. Inserting electrode from top into the ink channel, it is intricate to maintain the same arrangement of electrode while repeating the experiment. To overcome these problems a new approach of enclosing a metallic capillary by a tapered glass capillary nozzle as discussed in the previous chapter has been developed for the inkjet head. Metallic capillary is enclosed up to the preliminary point of the tapered section of the glass capillary. In this way the distance between the metallic capillary and glass capillary orifice can be maintained fixed all the time. Glass capillary with reduced nozzle orifice is used because as the nozzle diameter decreases, the electric field along the periphery of the meniscus can be made more concentrated. A P-97 Flaming/Brown Micropipette Puller has been used for making glass capillaries of 80 μm orifice size. Pulling parameters were kept the same so as to get the same tapered section of the glass nozzle which in turn facilitates in maintaining the same expanse between metallic capillary apex and glass nozzle orifice.

5.5. Experimental Procedure

Three set of experiments were performed for the analysis and complete structure of thin film transistor. In the first place contact angle analyzer was used for finding various parameters of the inks. Direct patterning was accomplished via EHD jetting technique for the source and drain contacts. Semiconducting and dielectric layers were deposited by using electrospray deposition technique. Gate line was also inkjetted using EHD patterning.

5.5.1. Contact Angle Analyzer Experiment

Contact angle is the angle between the tangent to the drop's profile and the tangent to the surface at the intersection of the vapor, liquid and the solid. For solution processing the surface energy interplay between solid surface and the liquid determines whether a particular solution will wet a surface well Fig. 5.2 (a) or not Fig. 5.2 (b).

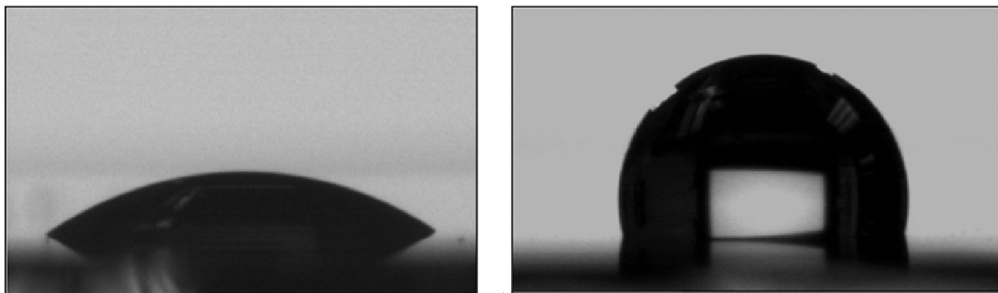

(a)

(b)

Fig. 5.2 (a) Droplets on hydrophilic, (b) Hydrophobic surfaces.

A high-quality film formation of the semiconductor is particularly important at the interface to the dielectric, where a conducting channel has to form for FET operation. Hence the investigation of surface energy properties of liquid semiconductor solutions and the relevant surfaces is crucial to the successful processing of FETs from solution. Contact angle analyzer experiment was used for investigation of the essential properties like contact angle, surface tension, work of adhesion and wetting energy of the inks. The wetting of a particular liquid on a solid surface is generally measured in terms of macroscopic contact angle on that surface [27]. The equilibrium contact angle is reached when a force balance is achieved at the intersection between the solid, liquid and vapor of the liquid under investigation. All these properties were found by using Surface Electro Optics (SEO) Phoenix equipment with image XP software. The experimental setup is shown in Fig. 3. System can be operated manually and also through software controlled mode. System setup consisted of, manual precision screw, syringe/needle, syringe control box, zooming lens with CCD camera, LED light source, stage and three axis motion control knobs.

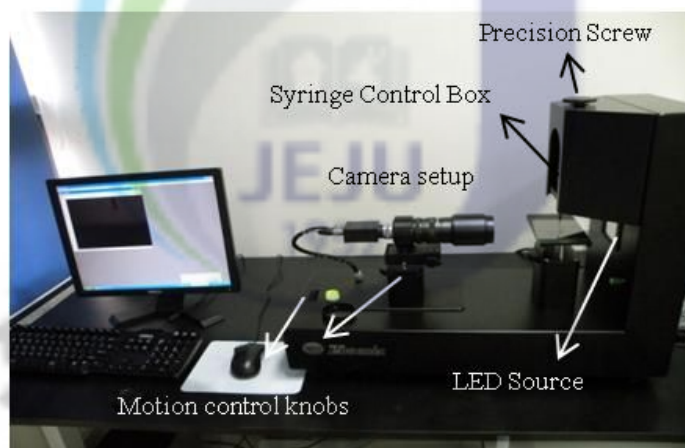

Fig. 5.3 Contact angle analyzer

5.5.2. Electrohydrodynamic Patterning and Spray Experiments

Similar experimental arrangement was followed for both patterning and spray deposition experiments. The prominent changes in experimental setup for patterning part were keeping very low distance between the nozzle and the counter electrode with minimized nozzle orifice.

Distance between the electrodes is changed to few orders of millimeters for electrospray experimental setup with also increasing the nozzle orifice size.

5.5.2 (a). EHD Patterning

Direct patterning of Ag nanoparticles based ink for gate, source and drain contacts was accomplished by using lab developed EHD inkjet system. The equipment used for patterning consist of a lab manufactured metallic enclosed glass nozzle , high voltage power supply, syringe pump for ink supply, X-Y stage motor control, substrate holder, high speed camera and nozzle holder with Z-axis control. Metallic enclosed glass nozzle with 80 μm orifice was used for the printing purposes. The configuration followed for the ejection in this patterning process was pin-to-plate with reduced distance between nozzle and substrate. In this setup the electric field produced, was obtained by the application of high electric potential between the two electrodes. Positive potential is applied to the capillary nozzle while ground is applied to the conductive plate kept at a distance of 1.2 mm below the nozzle tip. The liquid pressure was controlled by a syringe pump (Harvard Apparatus, PHD 2000 Infusion), flow rate was kept at 50 $\mu\text{l hr}^{-1}$. To maintain the uniform pressure, the inlet flow rate is very important because of ejection of the ink during the patterning process. High speed camera (Motion pro X4) with 11X zooming magnification of the lens is used for observing the phenomenon. Voltage was kept increasing until a stable meniscus was formed and continuous jetting of ink started. Optimum value of voltage applied in our setup was 4.3 kV. Schematic of the system and lab prepared experimental setup are given in Fig. 4.10 and Fig. 4.11 respectively in previous chapter.

Table 5.1. Experimental parameters for Ag patterning:

Parameter	Value	Parameter	Value
Nozzle type	Metallic enclosed glass nozzle	Nozzle size	80 μm
Ground type	Plate	Voltage	4.3 kV
Flow rate	50 $\mu\text{l/hr}$	Distance between Nozzle & Substrate	1.2mm

Different behavior of the meniscus and jetting observed by changing the applied voltage analyzed through high speed camera.

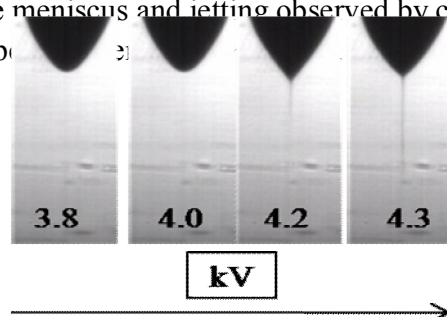

Fig.5.4 Different behavior of meniscus upon increasing the voltage for EHD patterning

5.5.2 (b). Electro spray Deposition of SiO₂ and ZnO

For analysis of ZnO and SiO₂ through electro spray deposition, similar arrangement of the lab developed system was used by altering the standoff in the EHD patterning system. Metallic capillary nozzles with inner diameter of 430 μm and 140 μm were used for SiO₂ and ZnO respectively. The same electrode's configuration of pin-to-plate was followed. Positive potential was applied to the capillary nozzle while ground applied to the conductive plate kept at a distance of 12 mm for SiO₂ and 35 mm for ZnO below the nozzle orifice. The flow rate was kept at 300 $\mu\text{l hr}^{-1}$ for SiO₂ while 250 $\mu\text{l hr}^{-1}$ for ZnO. Voltage was kept increasing until a stable meniscus was formed and spray started. The optimum value of voltage applied which gave good spray results was around 5.2 kV for SiO₂ and 7.7 kV for ZnO. Schematic of the electro spray system and lab developed system are given in Fig 5.5 & 5.6 respectively.

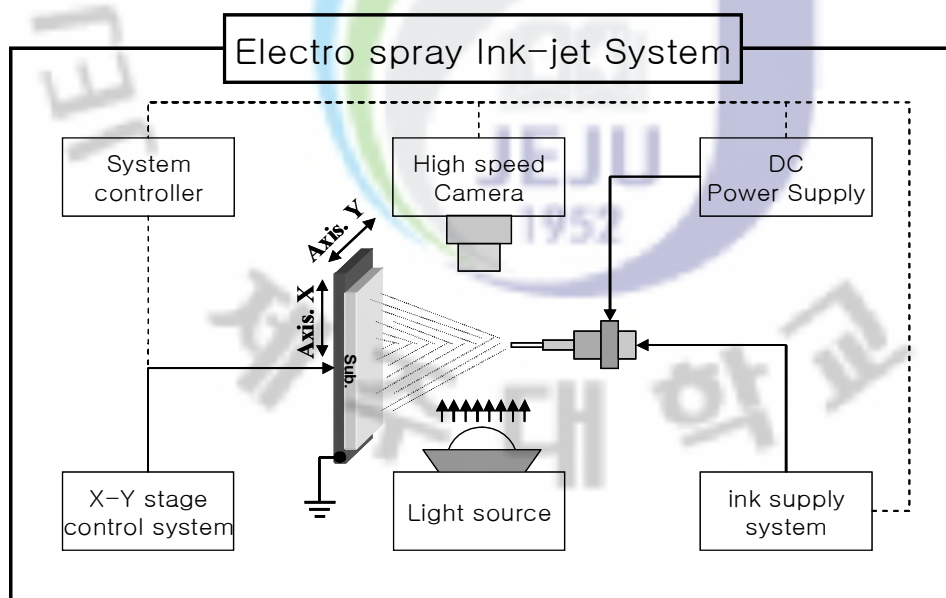

Fig. 5.5 Schematic of electro spray system

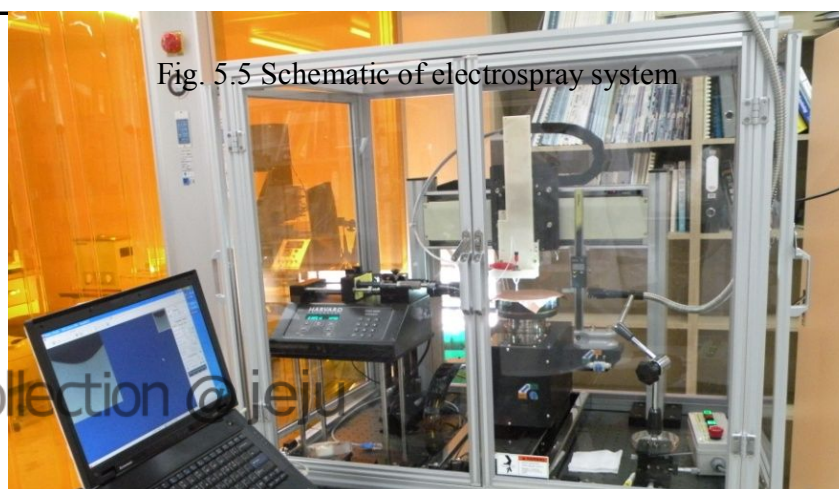

Fig.5.6 Lab developed electro spray system

Changing behavior of the meniscus and electro spray by changing the applied voltage was observed using high speed camera given in Fig. 5.7.



Fig.5.7 Different meniscus behavior of electro spray upon increasing voltage.

Electrospray results of ZnO have already been reported by our research group [28]. Experimental parameters are given in Table. 5.2.

Table 5.2. Experimental parameters for SiO₂ and ZnO Electro spray:

Parameter	Value	Parameter	Value	
Nozzle type	Metallic	Nozzle size	SiO ₂	ZnO
			430 μm	140 μm
Ground type	Plate	Voltage	5.2 kV	7.7 kV
Distance between Nozzle & Substrate	12mm for SiO ₂ 35mm for ZnO	Flow rate	300 μl/hr	250 μl/hr

5.6.1. Contact Angle Analyzer Results

Contact angle analysis of ZnO with glass substrate is given in the Table. 3. Contact angle values of SiO₂ were measured upon the electrospray deposited layer of ZnO and the values are given in Table. 4. Following the preferred bottom contact top gated structure of the thin film transistor in our research study, the sequence of analysis of the ink was also followed accordingly. On top of direct patterned Ag contacts and glass substrate, contact angle analysis of ZnO was done. A separate substrate of electrosprayed ZnO and sintered at around 350 C⁰ was used for the contact angle analysis of SiO₂. Properties like work of adhesion, contact angle, surface tension, spreading co-efficient and wetting energy were calculated.

Table 5.3. Contact angle analysis of ZnO on glass substrate:

Parameter	Value	Parameter	Value
Contact Angle	25.94 ⁰	Wetting Energy	65.46 mN/m
Spreading Coefficient	7.33 mN/m	Work of Adhesion	138.6 mN/m

Table 5.4. Contact angle analysis of SiO₂ on ZnO:

Parameter	Value	Parameter	Value
Contact Angle	18.65 ⁰	Wetting Energy	68.97 mN/m
Spreading Coefficient	3.82 mN/m	Work of Adhesion	141.76 mN/m

Contact angle provides a measure of surface energy. Low surface energy is preferable for thin film deposition because less energy is required for molecules to assemble into an energetically-stable and well-ordered film. The values of contact angle show that ZnO surface energy is more than the surface energy of SiO₂ due to large contact angle. In other words SiO₂ behaves as more hydrophilic than ZnO, Which confirms a promising behavior of the solutions if used for a top gated device. As the low values of contact angle show the strong interaction between liquid and substrate surface. Spreading of SiO₂ solution occurs more easily with good adhesiveness and wettability on the surface of ZnO layer based on the values attained during

analysis. The surface tensions of SiO₂ and ZnO found with the setup was 30.31 mN / m and 28.976 mN / m respectively. Fig 5.8 (a & b) shows the contact angle values of both the solutions.

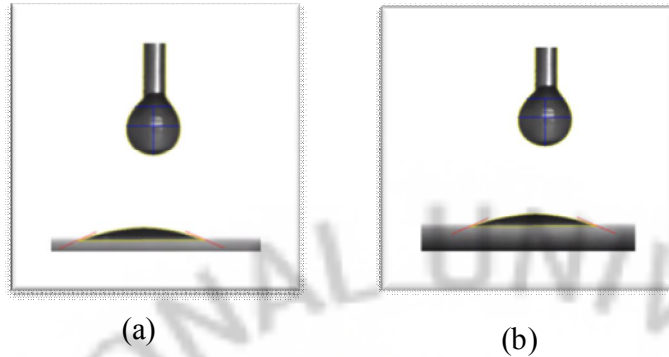

Fig. 5.8 a) Contact angle of ZnO, b) SiO₂ on glass substrate.

5.6.2. SEM and AFM Analysis of the Deposited Layers

For morphological study the deposited layers were analyzed using scanning electron microscope (SEM) for determination of the thickness achieved. After sintering the samples at 350 C° for 1 hour the deposited layers were sputtered with Platinum at 10 mA before testing the sample thickness. Both the samples were cured at the same temperature at normal conditions and environment. Thicknesses achieved were both in the acceptable range for thin film transistor. Average thickness achieved for SiO₂ was around 300 nm while for ZnO 100nm was achieved. Different samples being analyzed show that there is not much consistency in the thicknesses for both the layers. A standard deviation of around 25 nm was observed for the SiO₂ layer as the value is around 10 nm for the ZnO layer. One of the reasons for these inconsistencies might be the non-uniform particle size. Substrate heating is not introduced as it is one of the important experimental parameter for proper deposition and orientation of the nanoparticles on the substrate surface. The heating plate helps in evaporation of the surfactants being added in preparation of colloidal solution and fine layer in nanopowder form is achieved on the substrate. Fig. 5.9 shows schematic of the affects of heating substrate for electro spray deposition.

Thicknesses achieved and layer profile observed on the glass substrate and analyzed through scanning electron microscope are given in Fig.5.10 (a & b) and Fig 5.11 (a & b) respectively.

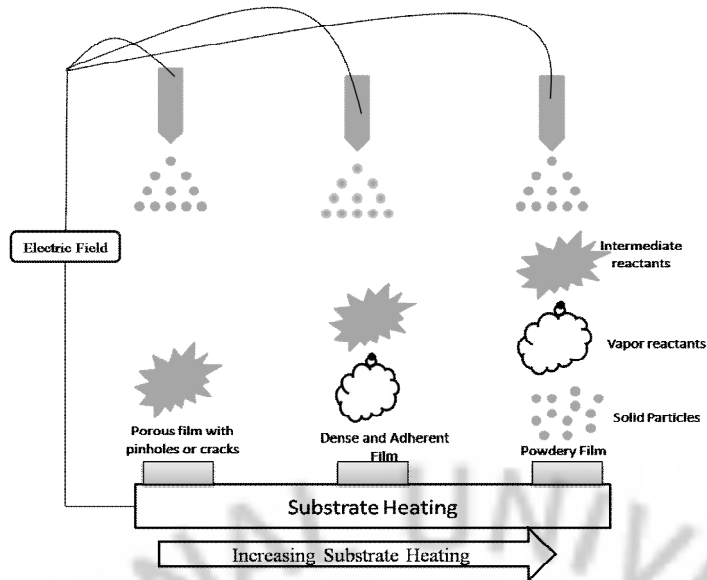

Fig.5.9 Schematic of substrate heating affect

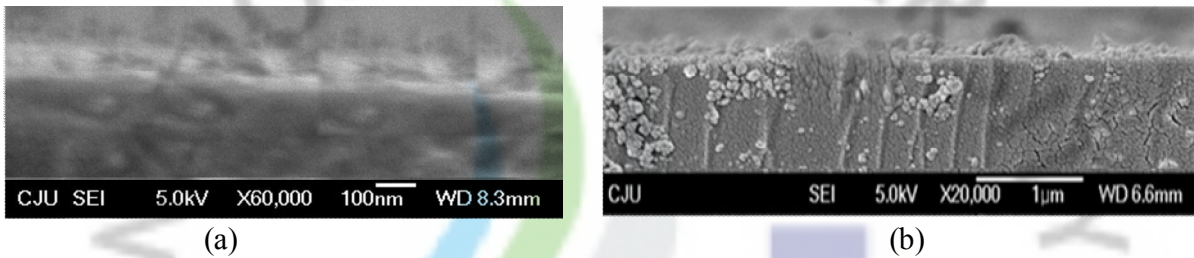

Fig.5.10. (a) SEM analysis of electrospayed ZnO, (b) SEM analysis of electrospayed SiO₂.

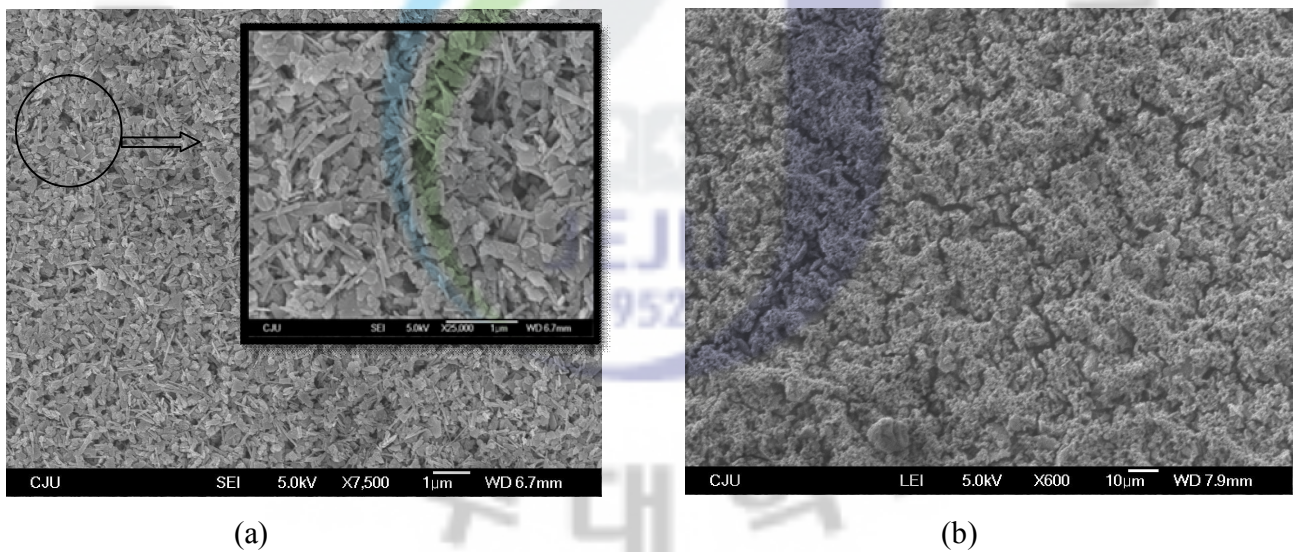
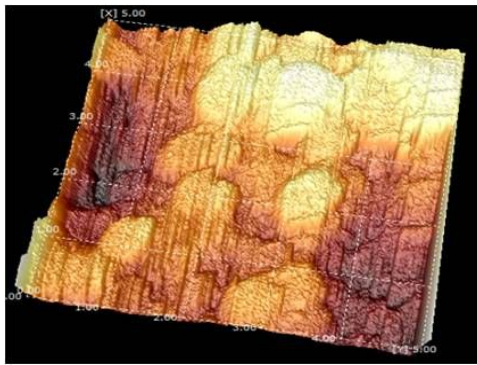
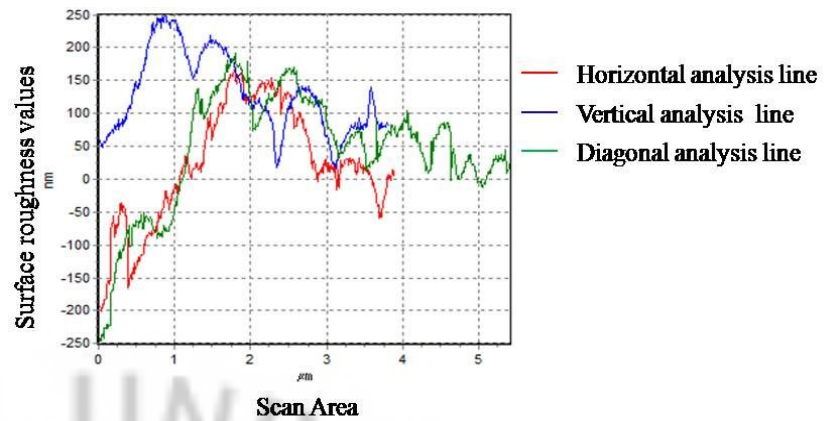

Fig.5.11. (a) Layer profile of electrospayed ZnO, (b) layer profile of electrospayed SiO₂

Surface roughness of both the layers was analyzed using atomic force microscope (AFM). No further modification of the surface was done. Fig. 12 (a & b) shows 3D view and surface roughness graphs of the ZnO layer while Fig. 13 (a & b) shows the 3D view and surface roughness graph of deposited SiO₂ layer.



(a)



(b)

Fig.5.12. AFM analysis of ZnO surface, (a) 3D view and (b). Surface roughness.

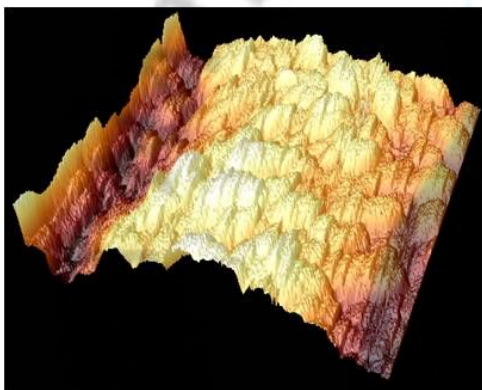

(a)

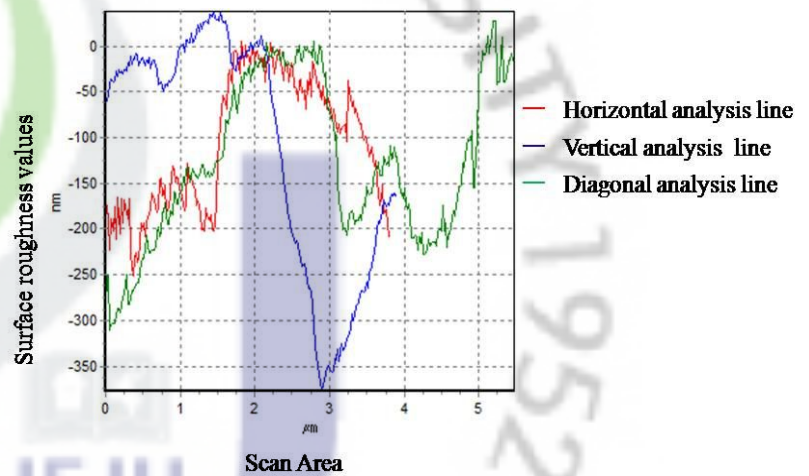

(b)

Fig.5.13. AFM analysis of SiO₂ surface, (a) 3D view and (b). Surface roughness

The red, blue and green lines in the graphs mentioned above show the horizontal, vertical and diagonal analysis lines respectively on the surface of each scanned sample through AFM in order to find the surface roughness in a specific area enclosed by these lines. Surface of the layers was not smooth as observed from the root mean square (RMS) values of the AFM analysis. The RMS value for SiO₂ was observed to be 150 nm while for ZnO the RMS value was 105 nm.

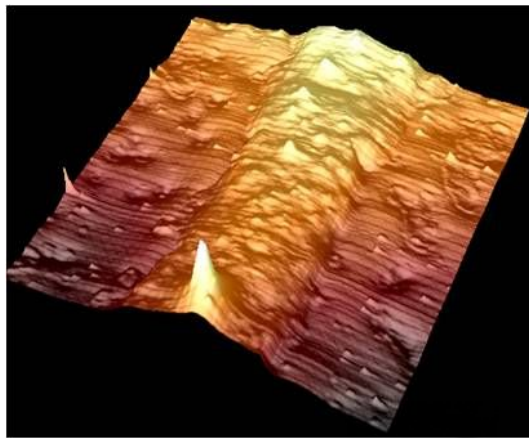

(a)

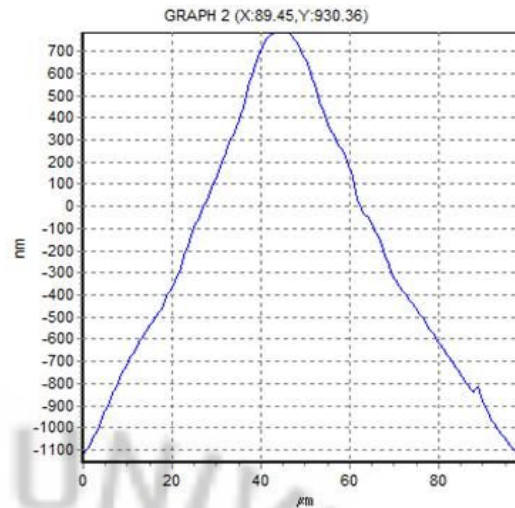

(b)

Fig.5.14. (a) 3D view of the printed line, (b) Thickness graph of printed lines

5.7. TFT Fabrication Integrating Electrohydrodynamic Printing and Spray Steps

In this research study processing steps for fabrication of all printed bottom contact structure of thin film transistor was developed using EHD inkjet technique and integrated it with electrospray for a full device manufacture. Optimum experimental parameters achieved during individual experiments set were followed for full device fabrication. Pursuing the bottom contact structure, the above mentioned processing steps were integrated in the following way. First of all glass substrate was properly cleaned using deionized water, ethanol and isopropyl alcohol. Further the glass substrate was treated using UV light. Two approaches of the basic structure i.e. bottom gate top contact and top gate bottom contact designs were followed.

5.7.1. Bottom gate structure:

For bottom gate structure, a conductive pattern line was drawn on clean glass substrate using Ag nanoparticles based solution. A conductive line of around 70μm achieved on the substrate was sintered at normal conditions in oven at 200 °C for 45 minutes. For deposition of dielectric (SiO₂) layer on the gate contact, electrospray deposition system was used by introducing a stencil mask covering 1.5 *1.5 mm² area for position specific deposition. The steps were repeated for deposition of semiconductor layer as well after sintering the dielectric layer at around 350⁰C. Source and drain contacts were deposited by electrospraying of Ag based colloidal with variable channel lengths. The channel lengths achieved using this configuration varied very inconsistently. Spreading of the ink across the edges of the mask added to the irregular channel lengths. Control of this process is very difficult in this configuration and

number of steps developed using direct mask is sometimes problematic. The experimental setup and proper deposition of the ink and specially the source and drain contacts is not able to achieve easily. Also the source and drain contacts achieved through electro spray didn't result in a complete in a solid line due to electro spray of the liquid. All the processing steps are given in the figure below.

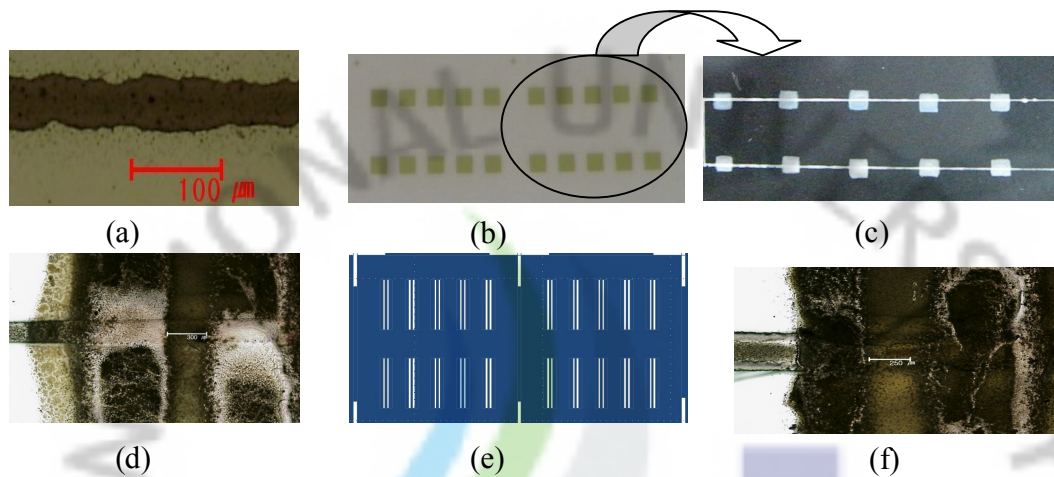

Fig. 5.15. Processing steps for bottom gated TFT, a) gate line on glass substrate. (b & c) Mask for Deposition of Dielectric and Semiconductor layers. (d, e, & f) Source and drain deposition with stencil mask used

5.7.2. Top gate Structure:

In order to omit the large variation in channel lengths introduced by electro spray deposition of Ag colloidal solution in bottom gate structure, the source and drain lines were directly printed using EHD patterning on glass substrate with Ag based (NPK) ink achieving channel length of around 50 μm . Here in this configuration the channel lengths can be controlled by properly tuning the axial movement of substrate holder. Line widths of the printed lines achieved were around 70 μm with good uniformity. After sintering the source and drain lines at 200 $^{\circ}\text{C}$ for 45 min, ZnO was electro sprayed on a $1.5 \times 1.5 \text{ mm}^2$ area using same stencil mask as used in the previous structure and the substrate was sintered at 350 $^{\circ}\text{C}$ for 1 hour. Mask was prepared by using a photomask with Mask Aligner system followed by etching and developing steps.

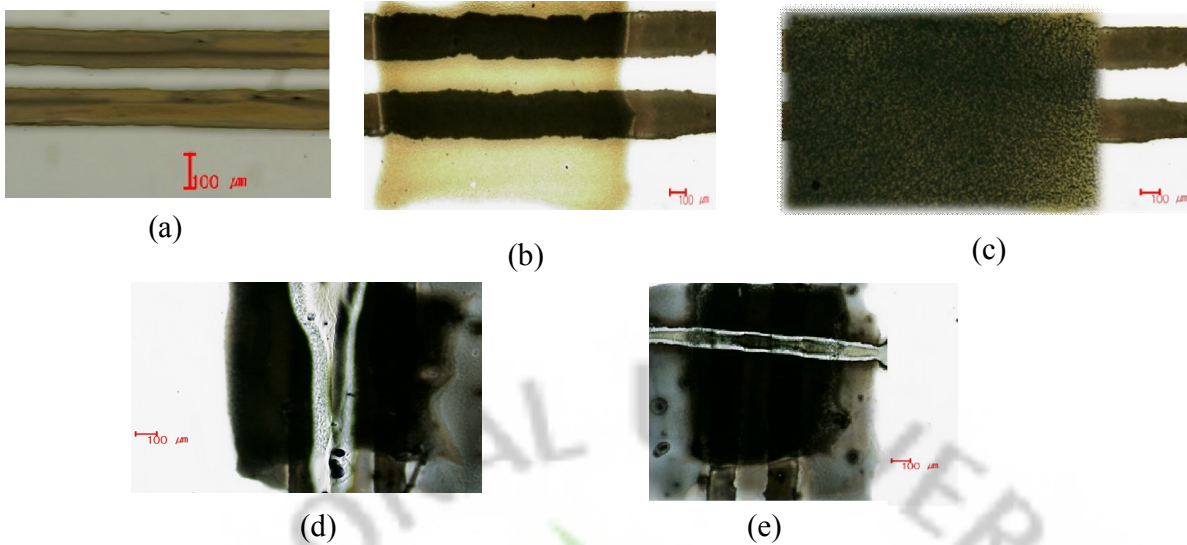

Fig. 5.16. Processing steps for top gated TFT, a) Source and drain, b) Electro spray of ZnO on source and drain contacts, c) Electro spray of SiO₂ on ZnO layer d) Parallel gate line with source and drain, e) Cross gate line with source and drain

Above ZnO layer SiO₂ was deposited using the same mask and sintered at the same temperature and conditions as ZnO. For gate line, same Ag nanoparticles based NPK ink was patterned using EHD inkjet technology achieving the same dimensions as source and drain contacts. Fig. 5.16 shows the process flow of the full fabrication of thin film transistor. Fig. 5.16 (a) shows the microscopic image of the source and drain lines patterned. Fig. 5.16 (b & c) shows the microscopic image of parallel gate line with source and drain and electro sprayed ZnO and SiO₂ on source and drain contacts. Fig. 5.16 (d & e) show microscopic image of the cross printed and parallel gate line with source and drain contacts of complete fabricated TFT. The top gated line is patterned directly in two ways in order to check for the available options for the channel width or in other words for defining the effective area of the channel layer. In first place a gate line of about 1mm was drawn upon dielectric layer and in parallel to the source and drain contacts. As the requirement for the channel width reported in most of the literature is supposed to be almost 10 times greater than the channel length for good device characteristics, this length in parallel configuration can further be manipulated easily. In the second cross configuration of gate line with the source and drain contacts, only effective width equal to the width of the printed line is achieved, which in our case is approximately 70um and is very low for the desired ration between channel length and width. So there is little room for latter configuration to be used effectively for proper development of the device parameters. Lab fabricated Mask has been used

for both the internal layers of dielectric and semiconductor. The processing steps developed in this study can successfully be employed for fabrication of organic based semiconductors. As mobility and electrical characteristics of organic semiconductors are accepted to be highly affected due to environmental affects. The structure presented here assures a partial encapsulation of the organic semiconductor as the dielectric material is deposited upon it.

5.8. Conclusion:

Key focus of the study in this research is to develop system and processing steps for direct fabrication of thin film transistor using electrohydrodynamic inkjet technology. EHD patterning and spray are non-contact and low cost techniques that can successfully revolutionize the manufacturing technology by plummeting various steps involved in development of thin film printed electronics. A stable inkjet head for uniform micro-patterning and electro spray has been developed and applied for manufacture of source, drain and gate contacts of thin film transistor. A thin film transistor with channel length of 50 μm and width of 1.5 mm is successfully fabricated. Current focus of the study is on the successful fabrication of the device using EHD technology and morphological analysis of the electro sprayed layer. This direct writing process can contribute a lot to the development of inexpensive and large area flexible electronics. Furthermore the local material deposition of inkjetting process could minimize material waste. All the experiments can be performed in ambient environment and no special conditions are needed throughout the fabrication process.

References:

- [1] E. Lee, *Microdrop Generation*, CRC Press, 2003.
- [2] S. Lee, D. Byun, S. J. Han, S. U. Son, Y. J. Kim, H. S. Ko, "Electrostatic Droplet Formation and Ejection of Colloid," *MHS*, July 31, 2004.
- [3] C.M. Ho, Fluidics-the link between micro and nano sciences and technologies, Proc. IEEE Int. Conf. MEMS, 2001, pp. 375–384.
- [4] Oliver Wilhelm: PhD Thesis, Swiss Federal Institute of Technology Zurich, 2004.

- [5] Y.E. Yee, J.B. Lee, Y.J. Kim, H.K. Yang, J.C. Park, H.J. Kim, Microstructural evolution and preferred orientation change of radio-frequency-magnetron sputtered ZnO thin films
- J. Vac. Sci. Technol., A 14 (1996) 1943
- [6] V. Craciun, J. Elders, J.G.E. Gardenievs, I.W. Boyd, Characteristics of high quality ZnO thin films deposited by pulsed laser deposition Appl. Phys. Lett. 65 (1994) 2963.
- [7] Y. Natsume, H. Sakata, T. Hirayama, Low-temperature electrical conductivity and optical absorption edge of ZnO films by chemical vapour deposition. Phys. Status Solidi, A 148 (1995) 485.
- [8] B J Norris, J Anderson, J F Wager and D A Keszler, Spin coated Zinc oxide transparent transistors, J. Phys. D: Appl. Phys. 36 (2003) L105–L107
- [9] K. Ogata, K. Sakurai, Sz. Fujita, Sg. Fujita, K. Matsushige, Effects of thermal annealing of ZnO layers grown by MBE, J. Cryst. Growth 214 (2000) 312.
- [10] Y. Natsume, H. Sakata, Zinc oxide films prepared by sol-gel spin-coating Thin Solid Films 372 (2000) 30.
- [11] O.V. Salata, Tools of nanotechnology: electrospray, Curr. Nanosci. 1 (2005) 25–33.
- [12] A. Jaworek: Electrospray droplet sources for thin film deposition J Mater Sci 42 (2007) 266–297
- [13] Jungmyoung Ju, Yutaka Yamagata, and Toshiro Higuchi: Thin-Film Fabrication Method for Organic light Emitting Diodes using Electrospray Deposition, Adv. Mater. 21 (2009) 4343-4347
- [14] A.Jaworek, A.T. Sobczyk, A.Krupa, M.Lackowski,and T.Czech, Electrostatic deposition of nanothin films on metal substrate, Bulletin of the Polish Academy of Sciences, Technical Sciences, Vol. 57 No. 1, 2009
- [15] Sa-Kyun Rha, Tammy P. Chou, Guozhong Cao, Youn-Seoung Lee, Won-Jun Lee, Characteristics of silicon oxide thin films prepared by sol electrophoretic deposition method using tetraethylorthosilicate as the precursor, Current Applied Physics 9 (2009) 551–555

- [16] I. Wuled Lenggoro, Hye Moon Lee, Kikuo Okuyama, Nanoparticles assembly on patterned 'plus/minus' surfaces from electrospray of colloidal dispersion, *Journal of Colloid and Interface Science* 303 (2006) 124–130
- [17] D. Z. Wang, S. N. Jayasinghe, M. J. Edirisinghe and Z. B. Luklinska, Coaxial electrohydrodynamic direct writing of nano-suspensions, *Journal of Nanoparticles Research* (2007) 9:825–831
- [18] S N Jayasinghe, M J Edirisinghe and D Z Wang, Controlled deposition of nanoparticles clusters by electrohydrodynamic atomization, *Nanotechnology* 15 (2004) 1519–1523
- [19] Camelia Matei Ghimbeu, Joop Schoonman, Martine Lumbreras, Maryam Siadat Electrostatic spray deposited zinc oxide films for gas sensor applications *Applied Surface Science* 253 (2007) 7483–7489
- [20] A. Jaworek, A. Krupa, A.T. Sobczyk, M. Lackowski, T. Czech S. Ramakrishnaf, S. Sundarrajan and D. Pliszka, Electrospray nanocoating of microfibers, *Solid State Phenomena* Vol. 140 (2008) pp 127-132
- [21] A. Jaworek, A.T. Sobczyk, A.Krupa, M. Lackowski, and T. Czech: 1st National conference of Nano and Micro Mechanics (KKNM08), Krasieczyn, 2008, p. 63.
- [22] A. Jaworek, A.T. Sobczyk, Electro spraying route to nanotechnology, *Journal of Electrostatics* 66 (2008) 197
- [23] Kyung Hyun Choi, Ahsan Rahman, J. B. Ko, Asif Rehmani, Adnan Ali, Y. D. Doh and D. S. Kim, Development and ejection behavior of different material-based electrostatic inkjet heads, *Int J Adv Manuf Technol*: 10.1007/s00170-009-2255-9
- [24] L.B. Loeb, A.F. Kip, G.G. Hudson and W.H. Bennet, Pulses in Negative point-to-plane Corona, *Physics Review* (1941), p.714-722
- [25] D.P.H Smith: *IEE Transactions on Industry Applications* (1986), P. 527-535
- [26] Joonwan Kim, "A Study on micro Patterning Method Using Electrically Controlled Nano-particle Deposition" Ph.D Thesis, The University of Tokyo, 2006
- [27] Paul Henrich Wobkenberg, *Thin Film Transistors for Large Area Opto/Electronics*, Ph.D Thesis, Imperial College London, 2009
- [28] Kyung Hyun Choi, Saleem Khan, Hyun Woo Dang, Yang Hoi Doh, and Sung Jei Hong, Electrohydrodynamic Spray deposition of ZnO nanoparticles, *Japanese Journal of Applied Physics* 49 (2010) 05EC08

Chapter # 6

Summary, Conclusion and Future Recommendations

6.1. Summary

Direct printing of microelectronic devices on a broad range of substrates by utilizing solution processed materials can accelerate bulk and roll-to-roll production on industrial scale. A wide range of organic and inorganic solution processed materials are being developed for targeted applications in passive and active electronic devices. Research for development of metallic, semiconductor and dielectric colloidal solution is in full swing in industrial and academic research institutes. Solution requirements and ink parameters vary depending on the printing approach followed. On the other hand selection of printing technology is based on the required resolution of patterning in the targeted electronic structures. Thermal and piezoelectric inkjet technologies are commercialized on industrial scale nowadays, but there are certain hindrances which are affecting the reliability of these inkjet printing systems. In order to avoid material problems, nozzle clogging and big droplets size than the nozzle orifice in thermal and piezoelectric inkjets, a new approach of high resolution printing and very small scale droplets than the nozzle orifice is developed and reported in this thesis. Electrohydrodynamic inkjet system can be applied successfully for very high resolution patterning without minimizing the orifice size of the nozzles. This new technique can also be exploited for direct deposition of functional materials on large area by changing a few experimental parameters without changing the whole systems setup. A new versatile inkjet nozzle head has been developed in this research and applied for the fabrication of thin film transistor. All these processing steps are reported for the first time in this thesis for direct fabrication of a thin film transistor using EHD technology. Direct printing of source, drain and gate lines has been achieved by using EHD patterning and a channel length of around 50 μ m is obtained successfully. ZnO and SiO₂ have been successfully

deposited for the active and dielectric layers of the device respectively, by following electrospray deposition technique. Acceptable values of surface roughness and thicknesses are observed. Two structures i.e. bottom gate and bottom contact are followed. In bottom gate, direct printing of gate contact on substrate and electrospray of source and drain on top of ZnO layer is fabricated while in bottom contact all the patterning is performed by following EHD patterning technique. Two different approaches for the gate contact i.e. gate contact in parallel to source and drain and gate contact in cross configuration to source and drain are achieved for better realization of channel width. The parallel structure of gate contact with the source and drain gives acceptable values of channel width as it can be defined by controlled movement of the inkjet head on the respective area. In the other case the channel width is totally dependent on the width of the printed line. A prototype of all printed thin film transistor has been fabricated following the developed steps in this research.

6.2. Conclusion and Future Recommendations

The simulation and experimental investigation of both inkjet heads configurations show that a very stable meniscus can be formed by using metallic enclosed glass capillary which results in enhancing the uniformity of the printed patterns on flexible substrates. The main reason for this is the minimized vibration caused by electrode with micron sized tip within the fluid which is affecting the meniscus stability. In MEG head configuration, resistance to the flow of fluid is omitted. The hollow conductor in the form of metallic capillary is used for smooth flow of fluid. As more area of the conductor is exposed to the fluid and the reduced distance between metallic capillary and orifice of the glass nozzle help in induction of electrical charges more quickly. EHD printing has a challenge of high speed printing which can be overcome by increasing the number of nozzle in the inkjet head. For that an optimized value of the nozzle orifice for very high resolution printing and for a specific solution is needed. This new MEG inkjet head helps in optimizing easily a standard value for a specific solution and fine manufacturing of the nozzle head as this is the most suitable configuration for multinozzles printing purposes. Preliminary experiments are also performed on multinozzles configuration showing acceptable results. Effects of electrode's position in the ink chamber can be maintained fixed with MEG print head for repeatability of the process parameters. Vibrations and whipping behavior of the meniscus at the tip are minimized. From this experimental study we conclude

that for high resolution and uniform printing, a stable meniscus plays very important role and a metallic enclosed glass capillary inkjet head can be used to enhance the stability of meniscus.

Key focus of the study in this research was to develop system and processing steps for direct fabrication of thin film transistor using electrohydrodynamic inkjet technology. EHD patterning and spray are non-contact and low cost techniques that can successfully revolutionize the manufacturing technology by plummeting various steps involved in development of thin film printed electronics. A stable inkjet head for uniform micro-patterning and electrospray has been developed and applied for manufacture of source, drain and gate contacts of thin film transistor. A thin film transistor with channel length of 50 μm and width of 1.5 mm is successfully fabricated. Current focus of the study is on the successful fabrication of the device using EHD technology and morphological analysis of the electrosprayed layer. This direct writing process can contribute a lot to the development of inexpensive and large area flexible electronics. Furthermore the local material deposition of inkjetting process could minimize material waste. All the experiments can be performed in ambient environment and no special conditions are needed throughout the fabrication process.

For future work and recommendations, fabrication of the newly proposed head by using MEMS technology in order to miniaturize it and addition of more nozzles in the configuration for development of multinozzles purposes. As speed of electrohydrodynamic inkjet technology can be increased by introduction and operation of more than one nozzle in order to compete for other robust direct write technologies. Major development in the electrospray system for avoiding the substrate and mask affects when placed in the path between nozzle and counter electrode. An integrated approach should be followed, in which the counter electrode is placed above the substrate and a holder for the mask must be designed in order to make the experimental setup easier. The distance between mask and substrate must be kept very small so that spreading of the sprayed particles must be confined on a specific spot and only be deposited on area of interest. Substrate heating is the main requirement of an electrospray system that must also be included in the new system design. Selection of material on the basis of compatibility with the substrate sustaining temperature and metallic contacts, organic materials should be explored for the dielectric and semiconductor layers of the device. Organic dielectrics and semiconductors can be obtained in solution form which provides smooth films on transparent

glass and plastic substrates. Organic materials are thermally stable up to 200⁰C with relatively small thermal expansion coefficient and can possess a rather high dielectric constant up to 18. Processing steps development for organic materials using electrospray or spin coating deposition and their integration with electrohydrodynamic inkjet patterning will successfully make way for realization of flexible transistors.

Publications Related to the Above Research

Journal Publications:

1. **Title:** Electrohydrodynamic Spray Deposition of ZnO Nanoparticles
Japanese Journal of Applied Physics (Published, 20th May 2010).
[DOI:10.1143/JJAP.49.05EC08](https://doi.org/10.1143/JJAP.49.05EC08)
2. **Title:** Direct Patterning and Electrospray Deposition through EHD for Fabrication of Printed Thin Film Transistors
Current Applied Physics (Published, 23rd November 2010)
[DOI: 10.1016/j.cap.2010.11.044](https://doi.org/10.1016/j.cap.2010.11.044)
3. **Title:** Development of electrostatic Inkjet head by integrating metallic and silica capillaries for stable meniscus,
International Journal of Advanced Manufacturing, Revised manuscript submitted.

Conferences :

- Oral Presentation at,
1. International Conference on Flexible and Printed Electronics 2009.
Title: Electrohydrodynamic Spray Deposition of ZnO nanoparticles.
 2. KSME Conference presentation .
Title: Comparison and analysis of patterning based on different ground configurations for polyimide substrate.
 3. Poster Presentation at
IUMRS- International Conference on Electronic Materials 2010.
Title: Direct Conductive Patterning through EHD Jetting for Printed Electronics.